

INFIRAY OUTDOOR  
**CABIN SERIES**

Thermal Imaging Monocular



## WARNING! ITAR REQUIREMENTS

These products may be subject to export and foreign trade control laws of the United States and may not be exported without prior approval of the U.S. Department of State. Learn more at [irayusa.com/ITAR](http://irayusa.com/ITAR).

### CAUTION

#### THIS PRODUCT IS A CLASS 3R LASER PRODUCT

Use of controls or adjustments or performance of procedures other than those specified herein may result in hazardous radiation exposure.

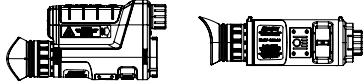

Explanatory Label

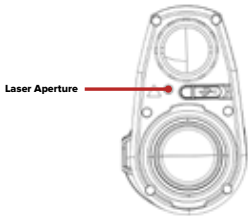

Mfr. ID and Certification Label



This Laser Product is designated as Class 3R during all procedures of operation.

Wavelength: 635nm  
Laser Power for classification: <5mW (4mW typical)  
Emission Type: CW  
Beam Diameter: <3mm at aperture  
Divergence: <1mRad

**LASER LIGHT  
AVOID DIRECT EYE EXPOSURE  
CLASS 3R LASER PRODUCT**

### NOTES

There is no scheduled maintenance or service necessary to keep this product in compliance and no user service or maintenance is required.

This product is to be serviced or repaired only by factory authorized technicians.

This product is not to be opened or modified by the user, nor is it allowed to attempt to cheat or defeat safety interlocks.

The user is not to modify the unit or remove protective covers or housing. Service is only to be handled by authorized factory trained technicians. This product has no user serviceable parts.

Do not point laser or allow laser light to be directed or reflected toward other people or reflective objects.

Operators should be trained to not target the eyes of people, animals and pets or aim at reflective objects etc.

There is a potential hazard of eye or skin exposure to laser radiation if the included instructions are not followed.

This laser is never to be operated if the unit is defective or the cover or seal is damaged.

Always operate the CABIN Series with the aperture pointed downrange.

## TABLE OF CONTENTS

<b>1. OVERVIEW</b>	<b>1</b>
<b>2. FEATURES</b>	<b>1</b>
<b>3. PACKAGE CONTENTS</b>	<b>1</b>
<b>4. TECH SPECIFICATIONS</b>	<b>2</b>
<b>5. UNITS AND CONTROLS</b>	<b>3</b>
<b>6. BATTERY AND SAFETY</b>	<b>5</b>
<b>7. EXTERNAL POWER SUPPLY</b>	<b>7</b>
<b>8. INSTALLATION AND USE</b>	<b>7</b>
<b>9. CALIBRATION</b>	<b>8</b>
<b>10. DIGITAL ZOOM</b>	<b>9</b>
<b>11. PHOTOGRAPHING AND VIDEO RECORDING</b>	<b>9</b>
<b>12. STATUS BAR OVERVIEW</b>	<b>11</b>
<b>13. SHORTCUT MENU</b>	<b>11</b>
<b>14. MAIN MENU</b>	<b>12</b>
ULTRACLEAR	12
WI-FI	13
VIDEO OUTPUT	13
CALIBRATION	13
DIGITAL COMPASS	13
GRAVITY SENSOR	14
LASER CURSOR CALIBRATION	14
PIXEL DEFECT CORRECTION	15
COMPASS CALIBRATION	15
STANDBY	16
IMAGE HUE	16
SETTINGS	16
DATE	16
TIME	16
LANGUAGE	17
STATUS AUTO HIDING	17
FACTORY RESET	17
INFO	18
<b>15. PICTURE IN PICTURE (PIP)</b>	<b>19</b>
<b>16. LASER INDICATOR</b>	<b>19</b>
<b>17. STADIAMETRIC RANGEFINDING</b>	<b>19</b>
<b>18. LED LIGHT</b>	<b>20</b>
<b>19. HOTSPOT TRACKING</b>	<b>21</b>
<b>20. AUTOMATIC HIDING</b>	<b>21</b>
<b>21. WI-FI FUNCTION</b>	<b>22</b>
<b>22. BASIC INSPECTION/MAINTENANCE</b>	<b>23</b>
<b>23. WARRANTY</b>	<b>23</b>
<b>24. FCC INFORMATION</b>	<b>24</b>
<b>25. GENERAL TROUBLESHOOTING</b>	<b>25</b>

## 1. OVERVIEW

The InfiRay Outdoor Cabin Series is a compact and powerful optic that operates easily with one hand. The CABIN is available with multiple lens options and its 50Hz 12 μm Micro II sensor featuring InfiRay's next generation MATRIX III processing ensures an unmatched viewing experience on its HD display. Standard features of the Cabin Series include a quick focus F:1.1 lens, stadiametric rangefinder, image and video capture, wireless connectivity, picture in-picture and an LED flashlight to guarantee you have everything you'll need in the palm of your hand.

## 2. FEATURES

- 12μm 50Hz High Frame Rate Sensor
- Matrix III Image Processing
- 1280x960 High-Definition Display
- Lightweight and Compact Design
- Intuitive User Interface
- 3100 mAh IBP-2 Battery Pack – 6+ hour runtime
- Quick Focus F1.1 Lens
- Stadiametric Rangefinder
- Defective Pixel Calibration
- Image and Video Capture
- Wireless App for Streaming and Data Transfer
- Digital Magnetic Compass and Gravity Sensor
- Picture-in-Picture Mode
- User friendly interface

## 3. PACKAGE CONTENTS

- CABIN Series Thermal Imager
- Hand Strap
- Neck Strap
- Portable Bag
- IBC-2 Power Adapter
- IBP-2 Battery Pack
- USB-C Cable for Video and Image Transfer
- Wall Adapter
- Lens Cloth
- Operating Manual



## 4. TECH SPECIFICATIONS

CABIN SERIES	CABIN CBL19	CABIN CBL25
<b>SENSOR</b>		
Resolution	384x288	
Pixel Size	12 μm	
Framerate	50hz	
Image Processing	MATRIX III	
Core	iRay Micro II 384	
<b>OPTICS</b>		
Objective Lens	19mm F1.0	25mm F1.0
Magnification	2.0X	2.5X
Digital Zoom	4X, stepped	
FOV	13.8°x10.4°	10.5°x7.9°
Detection Range	1070 Yards	1420 Yards
Display Type	LCOS	
Display Resolution	1280x960	
Imaging Modes	White Hot, Black Hot, Red Hot, Color, Highlight	
P.I.P.	Yes	
Rangefinder	Stadiametric	
Eye Relief	20mm	
Diopter Range	-5 - +5	
<b>ELECTRONICS</b>		
Onboard Recording	Video and Image	
Wireless Connectivity	Video/Image via App.	
Data/Power Connector	USB-C	
Power Supply	USB-C, IBP-2 Battery (6+ hour runtime)	
Laser	640 nm: 4.5mW CW	
Start Up Time	> 10 Seconds, Instant from Standby	
<b>PHYSICAL</b>		
Size	6.49"x1.96"x3.34"	
Weight	14.22 Oz	
<b>ENVIRONMENTAL/WARRANTY</b>		
Warranty	5 Years	
Housing Material	ABS, Magnesium	
Ingress Protection	IP67	
Operation Temp	-4°F~122°F	

\* Actual operation time depends on the duration of Wi-Fi and built-in video recorder use. Improvements may be made to the design and software to enhance features without prior notice.

## 5. UNITS AND CONTROLS

BUTTON	DEVICE STATUS/OPERATION MODE
POWER	Device is OFF
	Home Screen
	Standby
	Main Menu/Shortcut Menu
	Defective Pixel Calibration Interface
MENU	Home Screen
	Shortcut Menu
	Main Menu
	Laser Cursor Calibration
	Defective Pixel Calibration Interface
Up/Zoom	Home Screen
	Shortcut Menu/Main menu
	Laser Cursor Calibration/ Defective Pixel Calibration Interface
Down/Photo	Home Screen
	Shortcut Menu/Main menu
	Laser Cursor Calibration/ Defective Pixel Calibration Interface
Up/Zoom + Menu	Home Screen
Down/Photo + Menu	Home Screen

SHORT PRESS	LONG PRESS
---	Power ON the Device/Standby
Image Correction/NUC	Power OFF the Device/Standby
Wake Up the Device	---
Exit Menu/ Return to the Upper Menu	---
Add/Delete Defective Pixels	---
Open the Shortcut Menu	Open/Exit the Main Menu
Adjust Parameters of a Function	Exit the Shortcut Menu
Adjust Parameters of a Function/ Enter the Next Level	Save and Exit to Home Screen
Enable/Disable Cursor Movement	Save and Exit
Enable/Disable Cursor Movement	Select Save/Cancel
Digital Zoom: 2X - 8X	Turn PIP (Picture-in-Picture) ON/OFF
Navigation Up	---
Move Cursor Left	Quickly Move Cursor Left
Capture Image	Turn Recording ON/OFF
Navigation Down	---
Move Cursor Right	Quickly Move Cursor Right
Turn the Laser ON/OFF	Turn the Stadiametric Rangefinder ON/OFF
Turn ON/OFF and Adjust the LED Indicator	Turn Hotspot Tracking ON/OFF

1. Lens Cap
2. Laser Pointer
3. LED Light
4. USB-C Interface
5. Power Button
6. Up/Zoom Button
7. Menu Button
8. Down/Photo Button
9. Eye Cup
10. Diopter Adjustment Ring
11. Power Indicator
12. Quick Focus Knob
13. Battery Pack

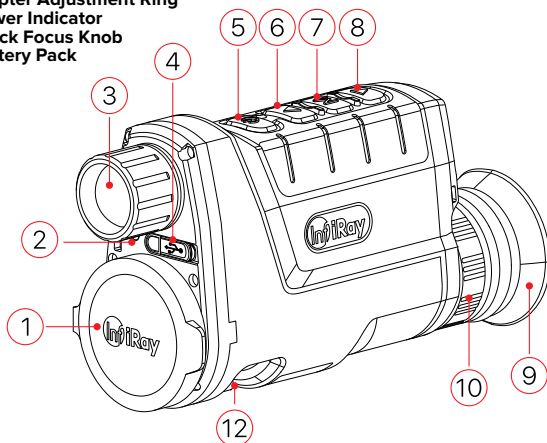

Note: The CABIN's laser function is hidden until you press and hold the "Up/Zoom + Menu + Down/Photo" buttons for more than 10 seconds. The laser function is turned ON after you hear the shutter click once.

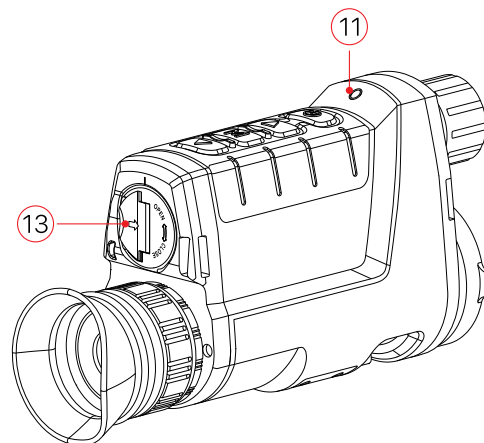

## 6. BATTERY AND SAFETY

The CABIN is supplied with a quick-change IBP-2 Li-Ion battery pack which enables the device to be used for up to 6+ hours. The battery should be fully charged before the first use.

### Charging the battery with USB-C Port

Install the Battery Pack into the Battery Port Compartment. For details, see Battery Pack Installation.

Connect the USB-C end (18) of the Data Cable to the USB-C port (4) of the Product.

Connect the USB end of the Data Cable to a USB Power Socket or power pack with an output voltage not exceeding 5V.

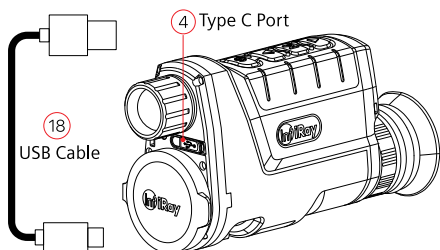

### Charging the battery with the IBC-2 Power Adapter

Align the Positioning Block of the Battery Pack (A) with the groove of the Battery Holder (B), and insert the Battery Pack (13) into the Battery Charger (15).

Connect the USB-C end of the USB Cable (18) to the USB-C port of the Battery Charger (15).

Connect the USB end of the USB Cable (18) to a USB adapter or power bank to charge the Battery Pack.

The LED Indicator on the Battery Holder (17) will now light up or blink:

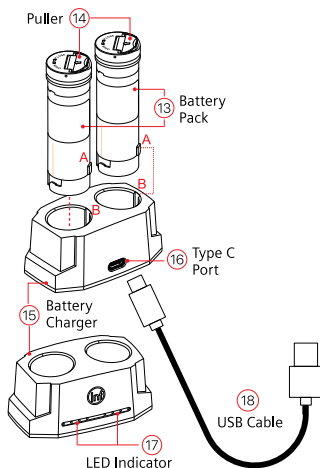

LED INDICATOR	BATTERY CHARGE STATUS
●	Battery Charging Capacity 1%-25%
● ●	Battery Charging Capacity 25%-50%
● ● ●	Battery Charging Capacity 50%-75%
● ● ● ●	Battery Charging Capacity 75%-99%
● ● ● ● ●	Fully Charged

After the battery is fully charged, remove the Battery Pack from the Battery Charger.

**⚠ Note:** The IBC-2 Battery Charger can charge two IBP-2 Battery Packs at the same time.

### Battery Pack Installation

Open the Puller on the Battery Pack (14) and align the Orange Line on the Battery Pack (D) with the Orange Line on the Battery Slot (C) and push the Battery Pack (13) into the Battery Slot (21).

When the Battery Pack is completely inserted into the Battery Slot turn the Puller (14) clockwise to lock the Battery Pack.

Close the Puller (14) and the Battery Pack is completely installed.

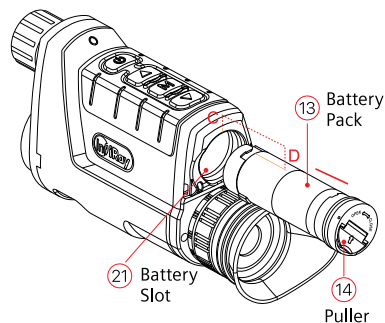

### Safety Measures

Use only the IBC-2 Battery Charger to charge the IBP-2 Battery Pack. Any other use will cause irreparable damage to the Battery Charger or Battery Pack and or cause a fire.

**IMPORTANT:** Before any length of storage, the Battery Pack should be partially charged - not fully charged or discharged.

Do not charge the battery immediately after you bring it from a cold area to a warm area. Wait 30 to 40 minutes for the battery to warm up.

Do not use the charger if it is modified or damaged.

The device should be charged at a temperature of 32°F to 115°F, otherwise the battery life will be significantly reduced.

When charging, don't leave the battery or charger unattended.

Do not expose the battery to high temperature or open flame.

Do not immerse the battery in water.

The IBC-2 Battery Pack has short circuit protection, but situations that may lead to short circuits should be avoided.

Do not charge the battery for more than 24 hours after it is fully charged.

Do not drop, attempt to disassemble or modify the IBC-2 Battery Pack.

The intended operating temp of the battery is -4°F to 122°F, it should not be used beyond this range as it may shorten the life of the battery.

When the device is used in sub-zero temperature the battery capacity will drop, this is normal and does not indicate a defect.

Keep the battery pack out of the reach of children.

## 7. EXTERNAL POWER SUPPLY

The CABIN will support the use of an external USB power supply (5V).

Connect an external power supply to the USB-C port of the CABIN (4) and the device will automatically switch to an external power supply while simultaneously charging the internal battery.

At this time, the Battery Icon on the display will become a Charging Icon  and the Power Indicator will turn red, then, turn green after the Battery is fully charged.

If an external power supply is connected, but no Battery Pack is installed, the Battery Icon will become a USB Icon  and the Power Indicator will turn green.

When the external power supply is disconnected the CABIN will automatically switch to the Battery Pack and operation will remain uninterrupted.

## 8. INSTALLATION AND USE

### Power-On and Operation

**WARNING! The lens of the CABIN must not be pointed at any sources of intense energy such as laser-emitting devices or the sun. This may damage the electronic components in the device. Damage caused by failure to comply with the operating guidelines is not covered under warranty.**

Remove the **Lens Cap (1)**. Press and hold the **Power Button (5)** for 2 seconds to power ON the device. Then, the Home Screen will appear after 3 seconds.

Rotate the **Diopter Adjusting Ring (10)** on the Ocular Lens until the symbology on the display is sharp. After this adjustment is completed there is no need to adjust the Diopter again unless the user changes.

Rotate the **Lens Focusing Knob (12)** to focus on the object observed.

Set the Image Mode: Press the **Menu Button (7)** to open the Shortcut Menu, and set the Image Palette Mode which is White-Hot, Black-Hot, Color, Red-Hot, and Highlight. The Palette Icon on the top Status Bar will be updated in real-time.

Select the user adjusted settings of Screen Brightness, Image Sharpness, Image Mode, and Digital Zoom (See the Shortcut Menu in this manual for details).

After using the CABIN, press and hold the **Power Button (5)** until the Shutdown Countdown Screen appears. When the countdown counts from 3 to 0, the device is now shut down. The current user selections will be automatically saved after shutdown. During the shutdown period, do not remove the battery or these selections will not be saved.

If you release the Power Button (5) before the end of the countdown, the CABIN will go into Standby. You can wake the CABIN from Standby by pressing the Power Button (5) briefly.

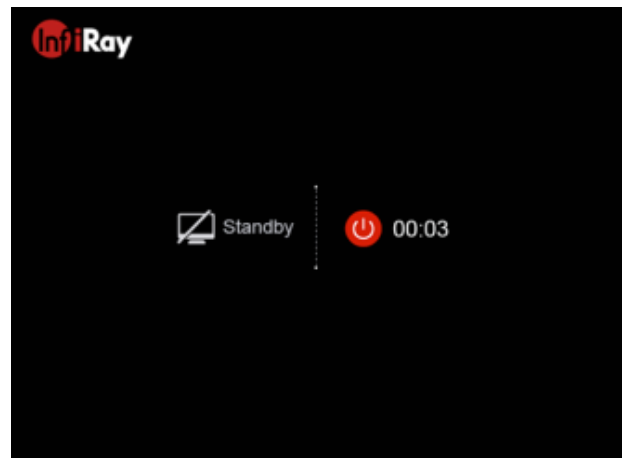

## 9. CALIBRATION

Image degradation is a normal function of a thermal imager, and should not be considered a defect.

When the image is degraded or uneven it can be automatically improved by calibration. Calibration unifies all pixels of the detector and eliminates any temporary defects visible in the image. There are three calibration modes: **Automatic Shutter Calibration (A)**, **Manual Shutter Calibration (M)**, and **Background Calibration (B)**. Select the desired mode in the "Calibration Mode" of the Main Menu.

**Automatic Shutter Calibration (A):** The device will automatically perform Shutter Calibration according to the Software Algorithm without installing the Lens Cap (the Sensor automatically closes its Internal Shutter). Before Automatic Shutter Calibration, there will be a 5 second countdown next to the Shutter Icon in the Status Bar. You can cancel the Calibration by pressing the **Power Button (5)** during the countdown. In this mode, you can also press the Power Button for Manual Shutter Calibration. You will hear a click during calibration, this is the internal shutter.

**Manual Shutter Calibration (M):** On the Home Screen, briefly press the **Power Button (5)** for Manual Shutter Calibration without installing the Lens Cap (the Sensor automatically closes the Internal Shutter). You will hear a click during calibration, this is the internal shutter.

**Background Calibration (B):** Install the Lens Cap and press the **Power Button (5)**. A text prompt will appear on the Home Screen "Cover lens during calibration!" The Background Calibration will start after 2 seconds. Remove the Lens Cap after Calibration. If you fail to cover the lens during a Background Calibration, temporary defects will appear in the image until a proper calibration occurs, this is not a defect and will not cause any permanent damage.

## 10. DIGITAL ZOOM

The CABIN Series features 1-4X digital zoom to increase visual magnification. On the home screen, press the Up/Zoom Button (6) to zoom the image in series; 1X-2X-3X-4X. The total visual zoom, corresponding to 1-4 times magnification of the native CABIN FOV is displayed in the top status bar.

## 11. PHOTOGRAPHY AND VIDEO RECORDING

The CABIN series is equipped with a built-in 16 GB of memory which allows for photo and video recording. The image and video files will be named with a time stamp, so it is recommended to set the system date and time in the main menu (Main Menu > Settings > Date), or synchronize the system date and time in the settings page of the App before using this feature.

### PHOTOGRAPHY

On the Home Screen, press the Down/Photo Button to take a photo. The picture will freeze for 0.5 seconds, and a photo icon  will appear in the upper right corner of the screen.

### VIDEO RECORDING

On the Home Screen, press and hold the **Down/Photo Button (8)** to start the video recording.

A recording icon and a tooltip showing the recording time will appear in the upper left corner of the display. The time format is 00:00:00 (hours | minutes | seconds).

During recording, you can also take a photo by briefly pressing the **Down/Photo Button (8)**.

Stop the recording and save the video by pressing and holding the **Down/Photo Button (8)**.

Image and video files are automatically stored in the built-in memory card after photography and video recording are turned OFF.





 Note: You can operate the menu normally during video recording and this will not be seen on your files. The photography images and recorded videos are stored in the built-in memory card in the format: IMG\_HHMMSS\_XXX.jpg (image) and VID\_HHMMSS\_XXX.mp4 (video). The file format HHMMSS means hours/minutes/seconds. The XXX means three-digit code of the multimedia file. This code of the multimedia file cannot be reset. The maximum duration of a video recording file is 10 minutes. When the duration is more than 10 minutes the video will be automatically recorded onto a new file. The number of files is limited by the capacity of the built-in memory of the device. It is recommended to check the remaining capacity of the memory card regularly, and transfer videos and images to other media to free up the space on the memory card.

### MEMORY ACCESS

When the device is turned ON and connected to a Windows computer it will be recognized by the computer as a flash memory card. This connection is used to access the memory of the device and allows you to access your images and videos.

Connect the device to a Computer through the Data Cable.

Turn ON the device.

Double-click "My Computer" on the desktop. Double-click to open the device named "Infiray."  Then, double-click to open the device named "Internal Storage"  to access the memory. 

There are different folders named by a time stamp in the format of xxxx (year), xx (month,) xx (day) in memory.







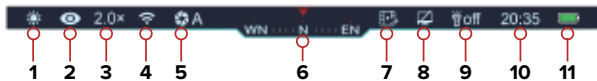







The photography images and recorded videos of each individual day are stored in these folders. You can copy or delete the required files or folders.



## 12. STATUS BAR OVERVIEW



The status bar is at the top of the screen and shows information on the actual operating status of the CABIN. From left to right the icons are:

- 1 - Current image mode (White Hot ; Black Hot ; Red Hot ; Highlight ; Color )
- 2 - Ultraclear Mode (Ultraclear off ; Ultraclear on )
- 3 - Current magnification (such as 2.0x)
- 4 - Wi-Fi Status (Wi-Fi off ; Wi-Fi on )
- 5 - Calibration Mode - In Automatic Shutter Calibration (A) Mode, 5 seconds before Automatic Calibration, a countdown icon  00:05 will be displayed next to the Calibration Icon instead of the letter (A). When the device is just started, it will automatically and continuously perform Shutter Calibration, but there will be no Countdown Icon. Only after the device is completely temperature stable (about 10 minutes of continuous operation) will there be a Countdown Icon for Automatic Shutter Correction.
- 6 - Compass (not displayed when the Compass is turned OFF)
- 7 - Video Output Status (not displayed when the Video Output is turned OFF)
- 8 - Automatic Standby Status (OFF by default)
- 9 - LED Indicator Status ( off upon startup by default)
- 10 - Clock (set in the Main Menu or set the time in the InfiRay Outdoor App)
- 11 - Battery Pack Indication: When the battery icon is in Green  it indicates that the power is greater than 20%. When it is in red  it means that the power is low and should be charged immediately. When a lightning bolt  appears in the middle of the battery icon, it indicates that an External Power Supply is powering the device. When CABIN is not charging, but connected to a computer,  USB icon will be displayed

## 13. SHORTCUT MENU

You can quickly adjust common functions through the Shortcut Menu: Image Mode, Screen Brightness, Image Sharpness, and Image Contrast.

On the Home Screen, briefly press the **Menu Button (7)** to access to the Shortcut Menu Interface.

Press the **Up/Zoom Button (6)** or **Down/Photo Button (8)** to switch the following options:

**Image Mode:** After selecting this option, press the **Menu Button (7)** to adjust the Image Mode. There are 5 modes: White-Hot, Black-Hot, Red-Hot, Color, and Highlight.

**Screen Brightness:** After selecting this option, press the **Menu Button (7)** to adjust the Screen Brightness from 1 (dim) to 5 (bright).

**Image Sharpness:** After selecting this option, press the

**Menu Button (7)** to adjust the Image Sharpness from 1 (lowest sharpness) to 5 (highest sharpness).

**Image Contrast:** After selecting this option, press the **Menu Button (7)** to adjust the Image Contrast from 1 (low contrast) to 5 (highest contrast).

Press and hold the **Menu Button (7)** to save these changes and return to the Home Screen.

 **Note:** In the Shortcut Menu, if there is no operation within 5 seconds the device will automatically save any changes and return to the Home Screen.

## 14. MAIN MENU

On the Home Screen, press and hold the **Menu Button (7)** to access the Main Menu.

Press the **Up/Zoom Button (6)** or **Down/Photo Button (8)** to switch between the Menu options.

The function options of the Main Menu are cyclical: When the cursor  reaches the last Menu option on the 1st page, it will start from the first Menu option on the 2nd page. When the cursor stays at the 1st option on the 1st page, you can press the **Up/Zoom Button (6)** to jump directly to the last Menu option on the 2nd page.

Press the **Menu Button (7)** to modify the parameters of the current option or go to the next level of the Menu.

The position of the cursor indicates the selected option, the icon of which will change from White to Blue.

The operation of second/third level Menus are the same as above.

Under all Menu interfaces, you can press and hold the **Menu Button (7)** to save changes and return to the Home Screen. Pressing the **Power Button (5)** will return to the upper Menu without saving changes.

Under all Menu interfaces, the device will return to the Home Screen when there is no operation within 15 seconds.

During continuous operation of the CABIN, when exiting from the Main Menu, the cursor remains at the last position before exiting. When you restart the CABIN and go to the Main Menu for the first time, the cursor will be at the first Menu option.

## MAIN MENU OPTIONS AND DESCRIPTIONS

### ULTRACLEAR

#### Turn Ultraclear mode on/off

Press and hold the **Menu Button (7)** to access the Main Menu Interface.

Short press the Up/Zoom Button (6) or Down/Photo Button (8) to select Ultra-Clear.

Short press the **Menu Button (7)** to enable or disable Ultra-Clear mode. You will hear a click of Shutter Calibration on selection.

The icon in the Status Bar also changes accordingly after this option is enabled or disabled.



## WI-FI

### Turn Wi-Fi on/off

Press & hold the **Menu Button (7)** to access the Main Menu Interface.

Short press the **Up/Zoom Button (6)** or **Down/Photo Button (8)** to select the Wi-Fi option.

Short press the **Menu Button (7)** to enable or disable Wi-Fi.

The icon in the Status Bar changes accordingly after this option is enabled or disabled.

## VIDEO OUTPUT

### Turn Video Output on/off

Press & hold the **Menu Button (7)** to access the Main Menu Interface.

Short press **Up/Zoom Button (6)** or **Down/Photo Button (8)** to select the Video Output option.

Short press the **Menu Button (7)** to enable or disable Analog Video Output.

The icon in the Status Bar changes accordingly after this option is enabled or disabled.

## CALIBRATION

### Select calibration mode

There are three calibration modes: **Automatic (A)**, **Manual (M)** and **Background (B)**

Press & hold the **Menu Button (7)** to access the Main Menu interface.

Short press the **Up/Zoom Button (6)** or **Down/Photo Button (8)** to select the Calibration Mode.

Short press the **Menu Button (7)** to enter the Secondary Menu of the Calibration function.

Short press the **Up/Zoom Button (6)** or **Down/Photo Button (8)** to select a mode from the following three choices:

**Automatic (A):** The image will be calibrated automatically.

**Manual (M):** The image will be calibrated by the user according to the level of image effect.

**Background (B):** The lens needs to be covered with a lens cap in this mode. The image will be calibrated manually by the user according to the level of image effect

Short press the **Menu Button (7)** to confirm the selection. The icon in the status bar will also change.

## DIGITAL COMPASS

### Turn the Digital Compass on/off

Press & hold the **Menu Button (7)** to access the Main Menu Interface.

Short press the **Up/Zoom Button (6)** or **Down/Photo Button (8)** to select Digital Compass option.

Short press the **Menu Button (7)** will enable or disable the Digital Compass function.

After the Digital Compass is enabled, its icon will be displayed in the middle of the status bar.

## GRAVITY SENSOR

### Turn the Gravity Sensor on/off

Press & hold the **Menu Button (7)** to access the Main Menu Interface.

Short press the **Up/Zoom Button (6)** or **Down/Photo Button (8)** to select the Gravity Sensor option.

Short press the **Menu Button (7)** to enable or disable the Gravity Sensor.

After the Gravity Sensor is enabled, its functions will be displayed on both sides of the Screen. The Curved Ruler on the left represents the Tilt Angle and the Vertical Ruler on the right represents the Pitch Angle.

## LASER CURSOR CALIBRATION

If the laser cursor differs from laser pointer point of impact, you can use this function to calibrate the cursor.

Long press the **Menu Button (7)** to access the Menu, short press the **Up/Zoom Button (6)** or **Down/Photo Button (8)** until you select the Laser Pointer Calibrate option.

Short press the **Menu Button (7)** to enter Laser Calibration. The laser indicator is enabled automatically.

The laser pointer appears in the middle of the screen and the following prompts are displayed in the upper left corner:

- X indicates the X-axis in the horizontal direction
- Y indicates the Y-axis in the vertical direction
- Center allows the pointer to return to the center of the screen
- Default allows the pointer to recover to factory settings

Short press the **Up/Zoom Button (6)** or **Down/Photo Button (8)** to switch between options and short press the **Menu Button (7)** to confirm the selection.

When selecting the X or Y axis, the icon of the selected option will keep blinking. Press the **Up/Zoom Button (6)** or **Down/Photo Button (8)** to move the pointer. If you press the **Up/Zoom Button (6)**, the pointer will move left/up. If you press the **Down/Photo Button (8)**, the pointer will move right/down. A short press moves the pointer a pixel each time, and a long press moves the pointer by 10 pixels each time.

If center/default is selected, the pointer will return to the center/default position after you short press the **Menu Button (7)**.

After moving the cursor to the location indicated by the laser, press and hold the **Menu Button (7)** to save the location and return to the home screen.

## PIXEL DEFECT CORRECTION

When using CABIN, you may see defective pixels such as light or dark spots within the image. To address this problem, you can access the Pixel Defect Correction function to correct these defective pixels.

Long press the **Menu Button (7)** to access the Menu, short press the **Up/Zoom Button (6)** or **Down/Photo Button (8)** until you select the Pixel Defect Correction option.

Short press the **Menu Button (7)** to enter the Pixel Defect Correction interface. A cursor will appear in the middle of the screen and the PIP function will be enabled automatically and in the lower left of the screen.

The right side of the PIP window will show the cursor direction of travel: X-axis (horizontal), Y-axis (vertical), and the number of total pixels calibrated.

Short press the **Up/Zoom Button (6)** or **Down/Photo Button (8)** to switch between the X and Y axis, then short press the **Menu Button (7)** to select the current axis.

Short press the **Up/Zoom Button (6)** or **Down/Photo Button (8)** to move the cursor on the current axis. If you press the **Up/Zoom Button (6)** the cursor will move left/up, and the **Down/Photo Button (8)** will move the cursor right/down.

After moving the pointer to the position of the defective pixel, short press the **Power Button (5)** to add and calibrate the pixel. "Add" is displayed in the PIP window, indicating that pixel has been successfully calibrated. Repeat the operation to calibrate any additional pixels.

You can delete any previous calibrations by short pressing the **Power Button (5)** again. "Del" is displayed in the PIP window.

Each time you add or delete a pixel calibration, the quantity of calibrated pixels will change accordingly.

When the pointer moves near the PIP window, the window and all info on the bottom left of the corner of the screen will move to the upper left corner automatically.

After finishing calibration, press and hold the **Menu Button (7)**. A dialog box will appear asking for confirmation to save the calibration. Short press the **Up/Zoom Button (6)** or **Down/Photo Button (8)** to select an option and then short press the **Menu Button (7)** to confirm your selection. Select "Yes" to confirm the setting and exit, or "No" to cancel the setting and exit.

## COMPASS CALIBRATION

### Calibrating the Digital Compass

Long press the **Menu Button (7)** to access the Menu, short press the **Up/Zoom Button (6)** or **Down/Photo Button (8)** until you select the Compass Calibration.

Short press the **Menu Button (7)** to enter Compass Calibration. The calibration icon will be displayed.

Rotate the device along the three axis indicated by the icon with each axis rotating at least 360° within 15 seconds. The calibration will end after 15s by default and exit the setting automatically.

## STANDBY

### Setting the Standby State and Duration

Long press the **Menu Button (7)** to access the Menu, short press the **Up/Zoom Button (6)** or **Down/Photo Button (8)** until you to select the Standby Settings option.

Short press the **Menu Button (7)** to enable or disable Standby.

The icon in the status bar changes accordingly after this option is enabled or disabled.

## IMAGE HUE

### Setting the screen image hue

Long press the **Menu Button (7)** to access the Menu, short press the **Up/Zoom Button (6)** or **Down/Photo Button (8)** until you select the Image Hue option.

Short press the **Menu Button (7)** to cycle between a warm or cool display tone.

Press and hold the **Menu Button (7)** to save and exit.

## SETTINGS

### Set Date, Time, Language, Automatic Status Hiding, Restore Factory Settings, and access Device Information.

## DATE

### Setting the System Date

Long press the **Menu Button (7)** to access the Menu, short press the **Up/Zoom Button (6)** or **Down/Photo Button (8)** until you access the Settings Menu.

Short press the **Up/Zoom Button (6)** or **Down/Photo Button (8)** to select the Date option.

Short press the **Menu Button (7)** to re-set the date. The date is in the format of YY/MM/DD.

Short press, or press and hold, the **Up/Zoom Button (6)** or **Down/Photo Button (8)** to set the year, month, and day.

Short press the **Menu Button (7)** to switch between the year, month, and day.

After setting the date, press and hold the **Menu Button (7)** to save and exit.

## TIME

### Setting the System Time

Long press the **Menu Button (7)** to access the Menu, short press the **Up/Zoom Button (6)** or **Down/Photo Button (8)** until you access the Settings Menu.

Short press the **Up/Zoom Button (6)** or **Down/Photo Button (8)** to select the Time option. The 24-hour view is used with hour and minute displayed.

Short press the **Menu Button (7)** to re-set the time.

Short press the **Up/Zoom Button (6)** or **Down/Photo Button (8)** to set the hour and minute.

Short press the **Menu Button (7)** to switch between the hour and minute.

After setting the time, press and hold the **Menu Button (7)** to save and exit.

After setting time, the time in the status bar changes accordingly

## LANGUAGE

### Selecting a Language

Long press the **Menu Button (7)** to access the Menu, short press the **Up/Zoom Button (6)** or **Down/Photo Button (8)** until you access the Settings Menu.

Short press the **Up/Zoom Button (6)** or **Down/Photo Button (8)** to select Automatic Status Hide. Short press the **Menu Button (7)** to enter its secondary menu.

Short press the **Up/Zoom Button (6)** or **Down/Photo Button (8)** to switch between English, German, Spanish, Russian and Chinese.

Short press the **Menu Button (7)** to confirm selection and exit to the home menu.

## STATUS AUTO HIDING

### Enabling/Disabling Automatic Status Hiding

Long press the **Menu Button (7)** to access the Menu, short press the **Up/Zoom Button (6)** or **Down/Photo Button (8)** until you access the Settings Menu.

Short press the **Up/Zoom Button (6)** or **Down/Photo Button (8)** to select Automatic Status Hide. Short press the **Menu Button (7)** to enter its secondary menu.

Short press the **Up/Zoom Button (6)** or **Down/Photo Button (8)** to enable or disable this function.

Short press the **Menu Button (7)** to confirm the selection and exit to return to the main menu.

## FACTORY RESET

### Restoring Factory Default Settings

Long press the **Menu Button (7)** to access the Menu, short press the **Up/Zoom Button (6)** or **Down/Photo Button (8)** until you access the Settings Menu.

Short press the **Up/Zoom Button (6)** or **Down/Photo Button (8)** to select the Factory Reset option. Short press the **Menu Button (7)** to access its secondary menu.

Short press the **Up/Zoom Button (6)** or **Down/Photo Button (8)** to select YES or NO. YES will restore factory settings and NO will cancel the operation.

Short press the **Menu Button (7)** to confirm the selection.

If YES is selected, the device will shut down automatically.

If NO is selected, the operation will be canceled and the upper menu will be displayed.

After Factory Reset is selected, the following functions will be restored to default settings:

**Image Mode:** White-Hot

**Ultra Clear Mode:** OFF

**Visual Amplification:** 2.0x

**Shutter Calibration:** A

**Compass:** OFF

**Standby:** OFF

**Analog Video:** OFF

**Wi-Fi:** OFF

**Gravity Sensor:** OFF

**Language:** English

**Automatic Status Hiding:** OFF

## INFO

### Querying Device Information

Long press the **Menu Button (7)** to access the Menu, short press the **Up/Zoom Button (6)** or **Down/Photo Button (8)** until you access the Settings Menu.

Short press the **Up/Zoom Button (6)** or **Down/Photo Button (8)** to select the Version Information option.

Short press the **Menu Button (7)** to access information about the current device.

Short press the **Menu Button (7)** or the **Power Button (5)** to exit to return to the upper menu.

## 15. PICTURE IN PICTURE (PIP)

Picture-in-Picture (PIP) provides a secondary window overlaid on the primary screen. This PIP window shows the center section of the main image enlarged to 2X.

On the home screen, press and hold the **Up/Zoom Button (6)** to enable or disable PIP.

After activating the PIP image, the image shown in the PIP window will also be enlarged when digital zoom is increased on the native image. For example, the image magnification on the home screen is 2.0X, 4.0X, 6.0X, 8.0X, and the corresponding magnification value of the image displayed in the PIP small window should be 4.0X, 8.0X, 12.0X, 16.0X.



## 16. LASER INDICATOR

The CABIN features a visible laser indicator which is hidden by default.

When using the laser feature for the first time, press and hold the **Up/Zoom Button (6) + Menu Button (7) + Down/Photo Button (8)** for more than 10 seconds. The laser indicator will be activated after hearing a shutter click.

On the home screen, short press the **Up/Zoom Button (6) + Menu Button (7)** to enable or disable the laser indicator once activated.



## 17. STADIAMETRIC RANGEFINDING

The CABIN provides a stadiametric rangefinding function which allows you to calculate your distance from an object with a known size.

On the home screen, press and hold the **Up/Zoom Button (6)** and the **Menu Button (7)** to enable the stadiametric rangefinding function.

After this function is enabled, two lines used for measuring will appear and icons representing 3 pre-configured object heights (Deer 5.5', Hog 3' and Rabbit 8") as well as their distance values in meters. To change the unit of measure between meter and yards, short press the **Menu Button (7)**.

Adjust these measurement lines to match the height of your target by pressing the **Up/Zoom Button (6)** or **Down/Photo Button (8)** to ensure that the measured object is within these lines. When you adjust these measurement lines, the rangefinding data on the right will also change accordingly.

Press and hold the **Up/Zoom Button (6)** and the **Menu Button (7)** to exit the stadiametric rangefinding mode.



## 18. LED LIGHT

The CABIN provides an LED light which can be quickly deployed and adjusted.

The LED light is disabled by default. Short press the **Menu Button (7) + Down/Photo Button (8)** to enable the LED light. At this time, the brightness is at level 2, and the status bar displays Light Icon 2.

Short press the **Menu Button (7) + Down/Photo Button (8)** again, the brightness will reduce to level 1, the status bar will now display Light Icon 1.

Short press the **Menu Button (7) + Down/Photo Button (8)** again to disable the LED light and the status bar will display the Light Icon OFF.



## 19. HOTSPOT TRACKING

The CABIN provides a hotspot tracking function which allows you to track the hottest object in the image.

On the home screen, press and hold the **Menu Button (7)** + **Down/Photo Button (8)** to enable hotspot tracking.

After this function is enabled, a blue box will appear in the image and track the hottest object automatically.

Press and hold the **Up/Zoom Button (6)** and the **Menu Button (7)** to exit hotspot tracking.



## 20. AUTOMATIC HIDING

This function is used to hide the graphical user interface (GUI) and allow for a full view of the screen.

In the main menu interface, short press the **Up/Zoom Button (6)** and the **Menu Button (7)** to select “Settings.”

Short press the **Menu Button (7)** to enter the secondary menu of “Settings” and short press the **Up/Zoom Button (6)** and **Down/Photo Button (8)** to select the “Automatic Status Hiding” function.

Short press the **Menu Button (7)** to enter the secondary menu of “Automatic Status Hiding.” Then, select ON or OFF.

After automatic status hiding is enabled, all GUI elements including the status bar will be automatically hidden and only the image will be displayed if there is no operation within 8 seconds.

Short press or press and hold any button to display the GUI, you can operate the buttons and the menu only after GUI information is displayed.

## 21. WI-FI FUNCTION

The CABIN has a built-in Wi-Fi module and can easily connect to a mobile device via an ultra-fast Wi-Fi connection.

Enable Wi-Fi in the main menu, referring to “Main Menu-Wi-Fi Settings.”

After Wi-Fi is enabled, search for the Wi-Fi signal that contains

your units serial number. Select the appropriate Wi-Fi option and enter the password. The initial password is 12345678.

After Wi-Fi is accessed, you can control the device via the mobile App.

### Setting Wi-Fi Name and Password

The CABIN allows you to change the name and password of the Wi-Fi in the App.

After the device is connected to the mobile device, locate the “Settings” icon in the InfiRay Outdoor app and tap it to enter.

In the text box, enter the new Wi-Fi name (SSID) and password.

After making a change, reset the device to activate the setting.

**⚠ Caution!**

After the device is restored to the factory setting, the name and password of the Wi-Fi will also be restored to the default factory setting.

### Product Update and Description to App

The CABIN supports wireless control with the InfiRay Outdoor app. You can transmit video or images in real time, operate the device, and update the software by connecting a smartphone or tablet via Wi-Fi. You can download the app by scanning the following QR codes.



After installing the App, open it on your smartphone or tablet.

If your CABIN has is connected to a mobile device, enable mobile data on that device. After data access is allowed, an update prompt will be displayed if applicable. Click “Now” to download the latest version immediately or click “Later” to download at a another time.

The InfiRay Outdoor App saves the last connected device and automatically checks for any available software updates. If an update is available when the App accesses the internet, you can download the update without being connected to the Cabin. The next time the Cabin is connected to the mobile device, you will be prompted to update the software at that time.

After the update is installed, the device will restart and operate as normal.

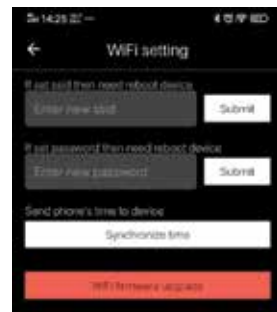



## 22. BASIC INSPECTION/MAINTENANCE

It is recommended to carry out a technical inspection every time before use.

Please check the following:

The CABIN's appearance, there should be no cracks in the body, or visible damage.

The condition of the objective lens and eyepiece, there should be no cracks, greasy spots, dirt or other deposits on the lenses.

The rechargeable battery should be fully charged.

The controls/buttons should be in working order.

### Basic Maintenance

Basic maintenance should be carried out at least twice a year and includes the following steps:

Wipe the external surface of metal and plastic parts off dust with a cotton cloth.

A blast of air may also be used for the cleaning process.

Clean the electric contacts and battery slots on the CABIN using a non-greasy organic solvent.

Check the optics of the lens and the eyepiece. If necessary, remove any dirt and sand from the optics. It is preferred to use a non-contact method such as a quick blast of air.

Cleaning of the exterior of the optics should be done with cleaners designed especially for this purpose, such as an optical quality wipe.

## 23. WARRANTY

At iRayUSA we're first and foremost hunters and users of our products and we understand that failure isn't an option. We also understand that having to wait extended periods for repair isn't something that a customer should have to put up with when something does go wrong. During your published warranty period, iRayUSA will repair or replace, at its discretion, any optic that becomes defective during normal use. Additionally, if we cannot fix your optic in less than one week, we will offer to replace it with a replacement product in like or better condition. If you would rather wait for your specific optic to be repaired, we can handle that too.

We know you've never seen this from a thermal manufacturer, neither have we, and that's why we started iRayUSA.

Our warranty follows the product, and is not tied to the original owner. The warranty period is tied to the date of sale to the dealer. This warranty only covers normal use and does not cover cosmetic damage, normal wear, intentional damage, theft, loss, any act of God or a condition caused by use other than intended. Any product that is modified, opened or tampered with will void any warranty coverage. Any serial number damage or alteration on the product will be considered modification.

Please give us a call at **800-769-7125**, visit **irayusa.com/warranty** email **Info@InfiRayUSA.com** with any questions.

This warranty gives you specific legal rights, and you may also have other rights which vary from state to state. One week starts from the time of receipt of product at iRayUSA. Customers must ship the product to iRayUSA, iRayUSA will return the product at no cost. No returns will be accepted without an RMA. iRayUSA is not liable for any damages or loss incurred when shipping to iRayUSA.

## 24. FCC INFORMATION:

FCC ID 2AYGT-CABIN

This device complies with part 15 of the FCC Rules. Operation is subject to the following two conditions: (1) This device may not cause harmful interference, and (2) this device must accept any interference received, including interference that may cause undesired operation.

### CAUTION

Changes or modifications not expressly approved by iRayUSA could void the user's authority to operate the equipment.

 Note: This equipment has been tested and found to comply with the limits for a Class B digital device, pursuant to part 15 of the FCC Rules. These limits are designed to provide reasonable protection against harmful interference in a residential installation. This equipment generates, uses and can radiate radio frequency energy and, if not installed and used in accordance with the instructions, may cause harmful interference to radio communications. However, there is no guarantee that interference will not occur in a particular installation. If this equipment does cause harmful interference to radio or television reception, which can be determined by turning the equipment off and on, the user is encouraged to try to correct the interference by one or more of the following measures:

Reorient or relocate the receiving antenna.

Increase the separation between the equipment and receiver.

Connect the equipment into an outlet on a circuit different from that to which the receiver is connected.

Consult the dealer or an experienced radio/TV technician for help.

This device was tested for typical body-supported operations and use. Third-party belt-clips, holsters, and similar accessories used by this device should not contain any metallic components. Body accessories that do not meet these requirements may not comply with RF exposure requirements and should be avoided. Use only the supplied or an approved antenna.

## 25. GENERAL TROUBLESHOOTING

The table lists problems that may occur when operating the BRAVO series. Carry out the recommended checks and troubleshooting steps in the order shown in the table. Please contact iRayUSA or an authorized vendor for assistance before attempting to perform any modifications or repairs beyond the scope of the troubleshooting procedures in this manual. Unauthorized repairs or modifications may void your warranty.

FAULT	POSSIBLE CAUSES
The CABIN will not turn on.	Battery is completely discharged
The CABIN will not work with an external power supply	USB cable is damaged.
	External power source is discharged.
The image is fuzzy, not clear, not balanced, with artifacts	Calibration is required.
The Image is too dark	Brightness level is too low.
The GUI is clear, but the image is fuzzy.	The lens is not focused.
	There is dust or condensation on the interior or exterior optical surfaces of the lens.
The CABIN cannot connect to a smart-phone or tablet.	The Wi-Fi password is incorrect.
	Too many Wi-Fi signals around the device.
The image of the object being observed is missing.	Looking through glass.
The image quality or contrast is poor.	Likely occurs when using the device in harsh weather, such as snow, rain, high humidity and fog.
When the device is used at a low temperature, the imaging quality is worse than that at normal temperature.	At temperatures above freezing, temperature differentials will increase between observed objects and the background. As a result, temperature contrast will increase, and the image quality will improve. At low temperatures, the background can cool down to a similar temperature and the image quality (fine detail) will decrease accordingly. This is a characteristic of all thermal imaging devices and should not be considered a defect.

**SUPPORT/SERVICE:** [irayusa.com/support](http://irayusa.com/support)  
[info@irayusa.com](mailto:info@irayusa.com)  
 800-769-7125

TROUBLESHOOTING
Charge the battery.
Replace USB cable.
Check the external power source.
Perform image calibration according to the Calibration section of this manual.
Adjust the brightness of the screen
Adjust the image sharpness by rotating the focus knob.
Wipe off the outside optical surfaces with a soft cotton cloth. Let the CABIN dry by leaving it in a warm, dry environment for 4 hours.
Enter the correct Wi-Fi password.
To enable stable network access, you are advised to move the device to an area with a limited number of Wi-Fi networks, or to an area without Wi-Fi coverage.
Remove any glass windows from the field of view.
—
—









**800 Railhead Road #316**  
**Fort Worth Tx 76106**  
**800-769-7125**  
**682-499-0047**  
**info@irayusa.com**