



Digital Day & Night Vision Scope

ALPEX LRF 4K Series

User Manual V5.5.72 202312



Contact Us

CONTENTS

1	Overview.....	1
1.1	Main Function	1
1.2	Appearance.....	1
2	Preparation.....	4
2.1	Cable Connection	4
2.2	Install Battery	4
2.2.1	Battery Instruction	4
2.2.2	Battery Installation.....	4
2.3	Mount Device on Rail.....	5
2.4	Install IR Torch.....	7
2.5	Power On/Off	8
2.6	Auto Screen Off	9
2.7	Menu Description.....	10
2.8	App Connection	10
2.9	Firmware Status.....	11
2.9.1	Check Firmware Status	11
2.9.2	Upgrade Device.....	12
2.10	Zeroing	13
3	Image Settings.....	14
3.1	Adjust Diopter	14
3.2	Adjust Focus	14
3.3	Adjust Aperture.....	15
3.4	Adjust Brightness	15
3.5	Adjust Contrast.....	15
3.6	Switch Day and Night	16
3.7	Set Smart IR	17
3.8	Set Picture in Picture Mode	17
3.9	Adjust Digital Zoom	18
3.10	Set Pitch Scale.....	19
4	Zeroing	20
4.1	Set Reticle Mode.....	20
4.2	Select Zeroing Profile	20

Digital Day & Night Vision Scope User Manual

4.3	Set Reticle	21
4.4	Correct Reticle	22
4.4.1	Correct Reticle on Device	22
4.4.2	Correct Reticle via HIKMICRO Sight	24
5	Measure Distance	26
6	Ballistic Calculation for Hunting.....	27
7	General Settings.....	29
7.1	Set OSD	29
7.2	Set Brand Logo	29
7.3	Capture and Video	30
7.3.1	Capture Picture	30
7.3.2	Set Audio	30
7.3.3	Record Video.....	30
7.3.4	Prerecord Video	31
7.3.5	View Local Files	31
7.4	Export Files	32
7.4.1	Export Files via HIKMICRO Sight	32
7.4.2	Export Files via PC	33
8	System Settings	35
8.1	Adjust Date.....	35
8.2	Synchronize Time	35
8.3	Set Language	35
8.4	Set Unit	36
8.5	View Device Information	36
8.6	Restore Device	36
9	Frequently Asked Questions.....	38
9.1	Why is the monitor off?	38
9.2	The image is not clear, how to adjust it?.....	38
9.3	Capturing or recording fails. What's the problem?	38
9.4	Why the PC cannot identify the device?	38

1 Overview

HIKMICRO ALPEX LRF 4K Digital Day & Night Vision Scope can perform in all ambient light that is present. With an advanced 3840 × 2160 FHD detector and F1.2 to 2.5 adjustable aperture, it provides ultra-clear and vivid full-color clarity in daytime and classic black & white viewing at night. Equipped with an extra accurate built-in laser rangefinder module, it is with the traditional-style tube design, meeting the needs of professional hunters who value traditions and seek technological superiority. The scope is suitable for field and forest hunting, adventuring, and rescuing.

1.1 Main Function

- **Distance Measurement:** Built-in laser range finder provides an accurate distance between the target and the observation position.
- **Adjustable Aperture:** Aperture adjustment ring helps you to adjust the size of aperture to accommodate various light conditions.
- **Switch Day and Night:** The day/night/auto mode allows you to use device in different environment.
- **Zeroing:** The reticle helps you to aim at the target fast and accurately. See *Zeroing*.
- **Auto Screen Off:** The function allows the device to enter standby mode/wake up through angle changes. The function darkens the screen to save energy and increase battery time.
- **Recoil-activated Video:** the device can automatically start recording before the recoil-activation and end recording after the recoil-activation.
- **App Connection:** The device can capture snapshots, record videos, and set parameters by HIKMICRO Sight app after being connected to your phone via hotspot.

1.2 Appearance



Note

- The appearance may vary according to different models. Please take the actual product for reference.
-

Digital Day & Night Vision Scope User Manual

- Pictures in this manual are for illustration purpose only. Please take the actual product for reference.

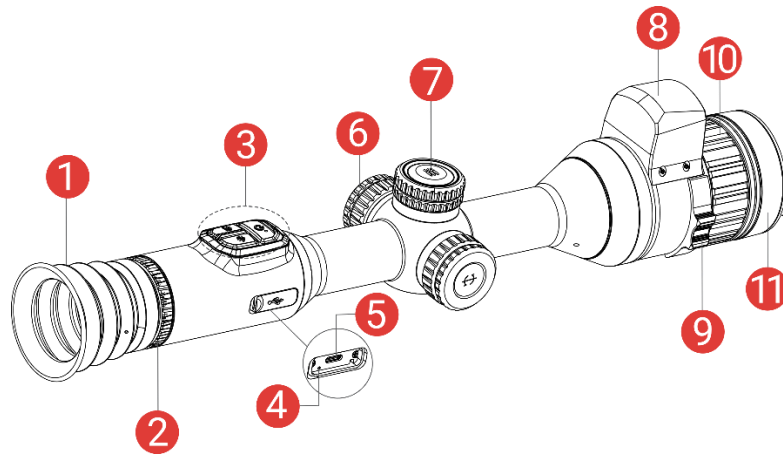

Figure 1-1 Appearance





Table 1-1 Description of Components

No.	Component	Description
1	Eyepiece	The piece placed closest to the eye to view the target.
2	Diopter Adjustment Ring	Adjusts the dioptic setting
3	Buttons	To set functions and parameters.
4	Charging Status Indicator	Indicates the charging status of the device. <ul style="list-style-type: none"> ● Flashing Red & Green: Error occurred. ● Solid Red: Charging. ● Solid Green: Fully charged.
5	Type-C Interface	To connect the device to power supply or transmit data with a type-C cable.
6	Battery Compartment	For holding the battery.
7	Wheel	To select functions and parameters and switch digital zoom.
8	Laser Rangefinder	Measures the distance to the target with laser.
9	Aperture Adjustment Ring	To adjust the size of aperture.

No.	Component	Description
10	Focus Ring	Adjusts focus to obtain clear targets.
11	Lens Cover	Protects the lens.

Button Description

Table 1-2 Button Description

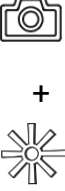
Icon	Button	Function
	Power	<ul style="list-style-type: none"> ● Press: Standby mode/Wake up device. ● Hold: Power on/off.
	Capture	<ul style="list-style-type: none"> ● Press: Capture snapshots. ● Hold: Start/Stop recording videos.
	Laser	<ul style="list-style-type: none"> ● Press: Turn on/off laser ranging. ● Hold: Turn on/off PIP (Picture-in-Picture).
	Wheel	<p>Non-Menu Mode:</p> <ul style="list-style-type: none"> ● Hold: Enter the menu. ● Rotate: Switch digital zoom. <p>Menu Mode:</p> <ul style="list-style-type: none"> ● Press: Confirm/Set parameters. ● Hold: Save and exit menu. ● Rotate: Move up/move down.
	Capture + Laser	Hold to lock/unlock the wheel.



Note

- The power indicator stays solid red when the device is on.
 - When the auto screen off function is enabled, if you press  to enter standby mode, you can also tilt or rotate the device to wake up the device. Refer to ***Auto Screen Off*** for detailed operation.
-

2 Preparation

2.1 Cable Connection

Connect the device and power adaptor with a type-C cable to power on the device. Alternatively, connect the device and PC to export files.

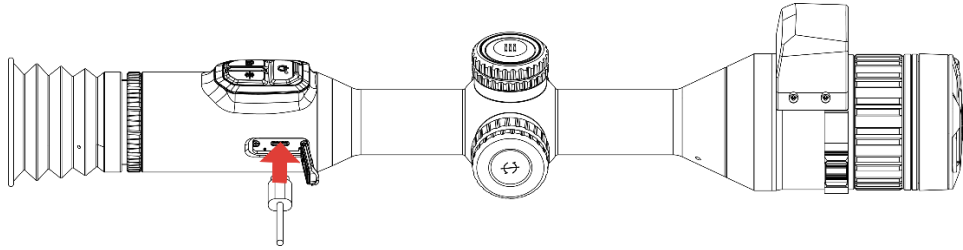

Figure 2-1 Cable Connection



Note

Charge the device for more than 6 hours before first use.

2.2 Install Battery

2.2.1 Battery Instruction

- Remove the external battery if the device is not used for a long time.
- The external rechargeable battery type is 18650, and the battery size should be 19 mm × 70 mm. The rated voltage is 3.6 V, and the battery capacity is 3200 mAh.
- The built-in battery type is rechargeable lithium-ion battery, and the battery size should be 23 mm × 67 mm. The rated voltage is 3.635 V, and the battery capacity is 3350 mAh.

2.2.2 Battery Installation

Insert the batteries into the battery compartment.

Steps

1. Turn the battery cover counterclockwise to loosen it.

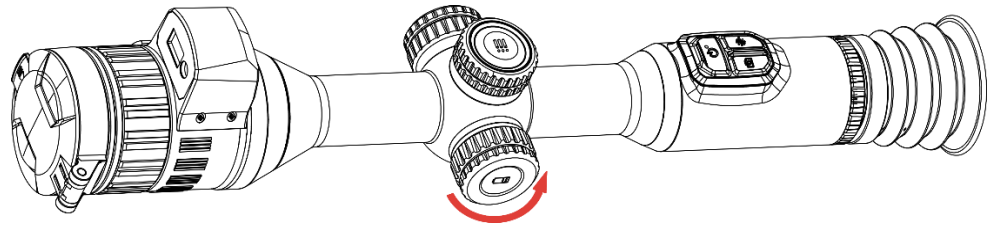

Figure 2-2 Loosen the Cover

2. Insert the battery into the battery compartment with the positive mark inward.

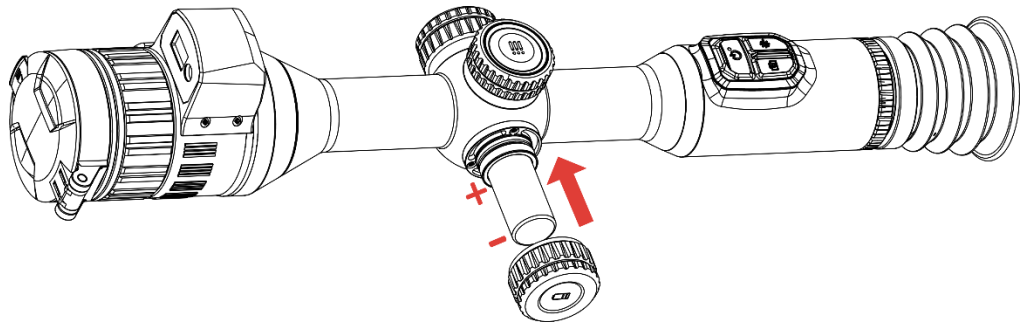

Figure 2-3 Insert the Battery

3. Turn the battery cover clockwise to tighten it.

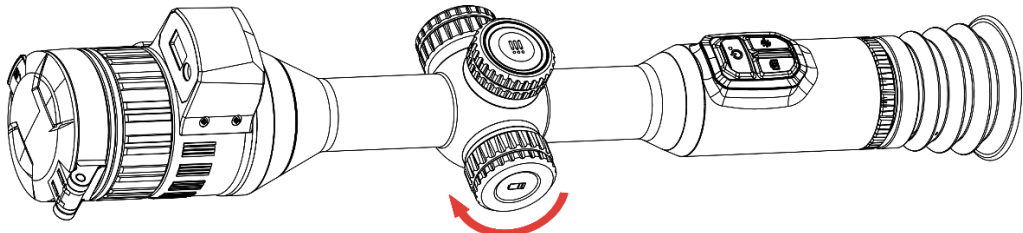

Figure 2-4 Tighten the Cover

2.3 Mount Device on Rail

Steps

1. Unscrew the ring top with Allen wrench.

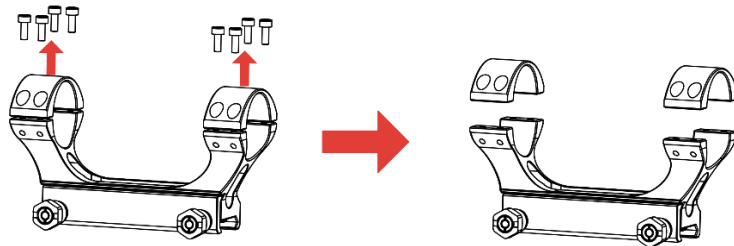

Figure 2-5 Unscrew the Ring Top

2. Place the device in the bottom half of the ring, and align the top holes with bottom holes.

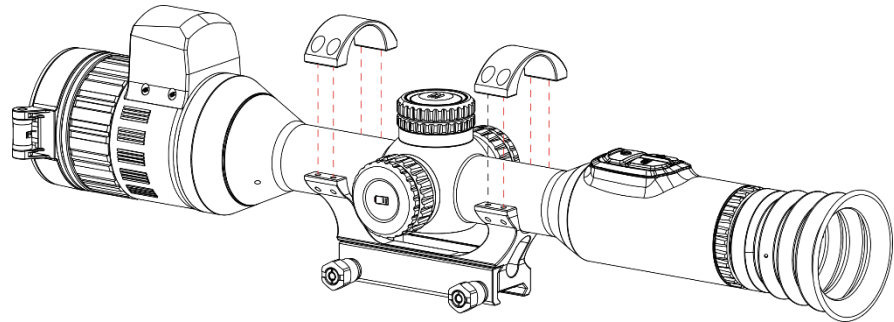

Figure 2-6 Place the Device in the Ring

3. Insert and tighten the screws.

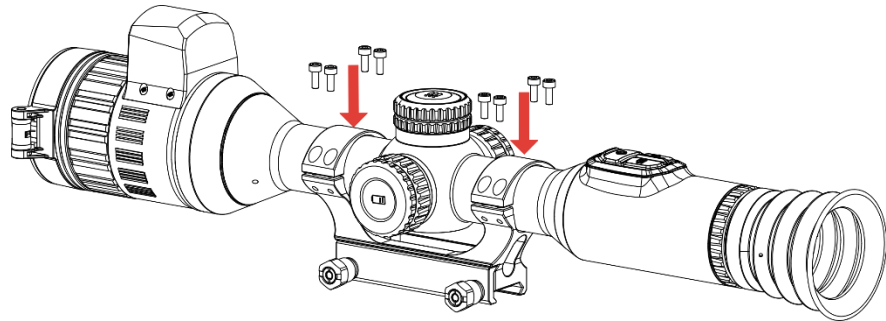

Figure 2-7 Tighten the Screws

4. Loosen the screws on the bottom half of the ring.

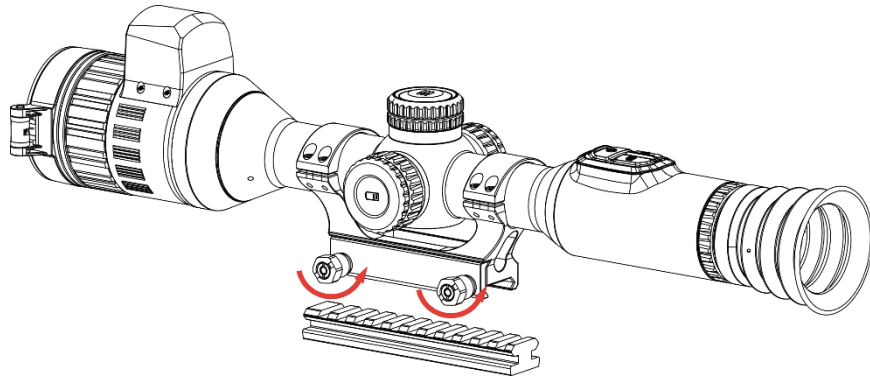

Figure 2-8 Loosen the Screws

5. Attach the bottom half of the ring to the rail, and tighten the screws on the ring. Make sure the device stays level.

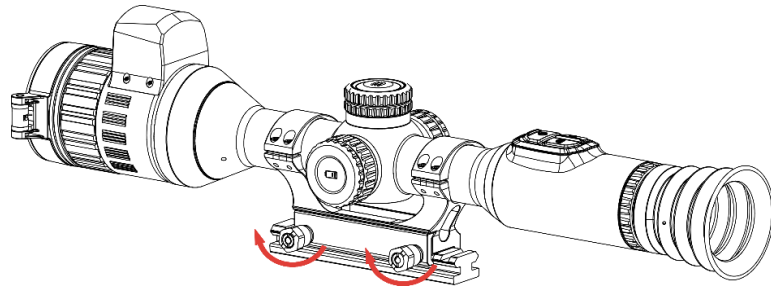

Figure 2-9 Tighten the Screws



Note

- The ring may vary according to different models. Please refer to the actual product.
 - Please purchase the ring separately.
 - Use lint-free cloth to clean the device base and the rail.
-

2.4 Install IR Torch

Steps

1. Open the IR torch bracket, and place the device in the IR torch bracket.

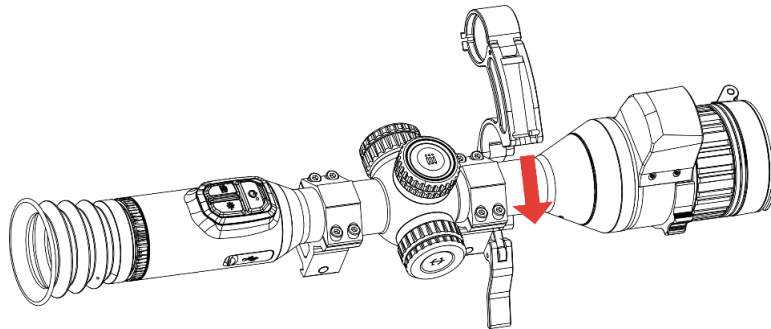

Figure 2-10 Open the IR Torch Bracket

2. Lock the lever by pressing it to fix the bracket as figure shows.

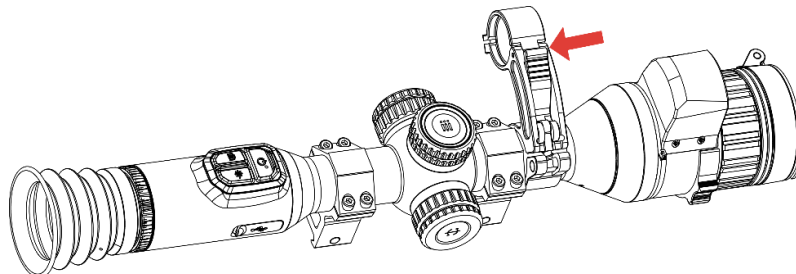

Figure 2-11 Lock the Lever

3. Turn the IR torch battery cover anticlockwise to remove it, and thread the IR torch through the bracket hoop, then turn the IR torch battery cover clockwise to tighten it.

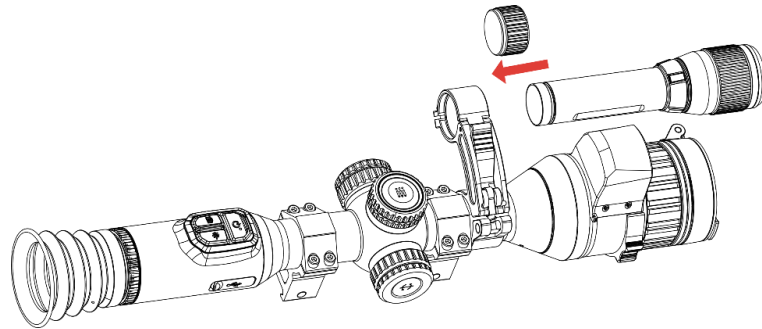

Figure 2-12 Thread the IR Torch

4. Tighten the screws to fix the IR torch.

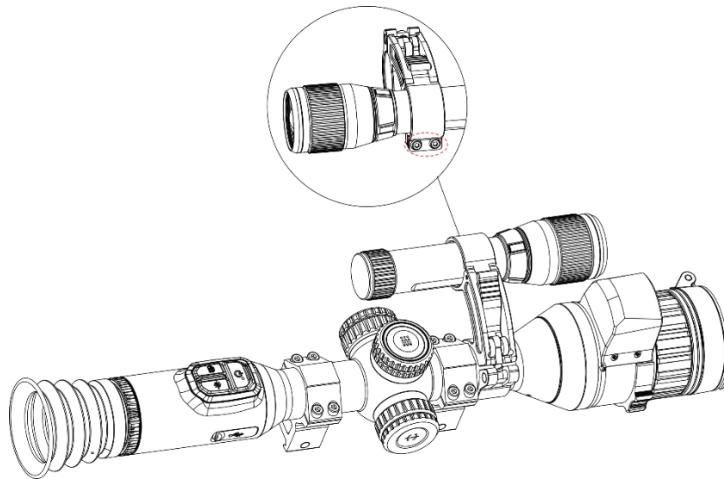

Figure 2-13 Fix the IR Torch



Note

- Rotate the lever to adjust the IR torch bracket. The lever would disassemble if continuously rotating it anticlockwise. Turn the lever clockwise to install it.
 - Please ensure the anti-slip pattern of the lever is outward when pressing the lever.
 - Please purchase the IR torch bracket and IR torch separately.
-

2.5

Power On/Off

Power On

When the device is connected to cable or the battery is enough, hold  to power on the device.

Power Off

When the device is turned on, hold  to power off the device.





Note

- Power-off countdown will appear when you power off the device. You can press any key to interrupt the countdown and cancel the power-off.
 - Automatic low battery power-off cannot be canceled.
-

Auto Power Off



You can set the auto power off time for your device.

Steps

1. Hold the wheel to show the menu.
 2. Go to  **Advanced Settings**, and select  **General Settings**.
 3. Rotate the wheel to select , and press the wheel to enter the configuration interface.
 4. Rotate the wheel to select the auto power off time as required, and press the wheel to confirm.
 5. Hold the wheel to save and exit.
-





Note

- See the battery icon for the battery status.  means the battery is fully charged,  means that the battery is low, and  means the battery charging is abnormal.
 - When the low power note shows, charge the battery.
 - The auto power off takes effect only when the device enters the standby mode and the device isn't connected with HIKMICRO Sight app at the same time.
 - The auto power off countdown will start again when the device reenters standby mode, or the device is restarted.
-

2.6 Auto Screen Off

Auto screen off function darkens the screen to save energy and increase battery time.

Steps

1. Enable auto screen off.
 - 1) Hold the wheel to show the menu.
 - 2) Go to  **Advanced Settings**, and rotate the wheel to select .
 - 3) Press the wheel to enable auto screen off.
 - 4) Hold the wheel to save settings and exit.
2. You can do one of the following methods to enter the standby mode when the display is turned on:
 - Tilt the device downwards more than 70°.
 - Rotate the device horizontally more than 75°.
 - Keep the device still and do not move it for 5 minutes.
3. You can do one of the following methods to wake up the device when the display is turned off:
 - Tilt the device downwards from 0° to 60° or upwards .
 - Rotate the device horizontally from 0° to 75°.
 - Press  to wake up the device.

2.7 Menu Description

In the live view interface, hold the wheel to show the menu.



Figure 2-14 Menu Description

2.8 App Connection

Connect the device to the HIKMICRO Sight app via hotspot, then you can capture picture, record video, or configure parameters on your phone.

Steps



1. Search the HIKMICRO Sight on App Store (iOS System) or Google Play™ (Android System) to download it, or scan the QR code to download and install the app.



Android System



iOS System

2. Hold the wheel to show the menu.
3. Go to  **Advanced Settings**, and rotate the wheel to select .
4. Press the wheel to enter the setting interface.
5. Rotate the wheel to select **Hotspot**. The hotspot function is enabled.
6. Turn on the WLAN of your phone and connect to the hotspot.
 - Hotspot Name: HIKMICRO_Serial No.
 - Hotspot Password: Serial No.
7. Open the app and connect your phone with the device. You can view the interface of device on your phone.



Note

- The device cannot connect to the app if you enter wrong password several times. Refer to **Restore Device** to reset the device, and connect the app again.
 - The device should be activated for the first use. The default password must be changed after the activation.
-

2.9 Firmware Status

2.9.1 Check Firmware Status

Steps

1. Open the HIKMICRO Sight and connect your device to the app.
2. Check if there is an upgrade prompt on the device management interface. If there is no upgrade prompt, the firmware is the latest version. Otherwise, the firmware is not the latest version.

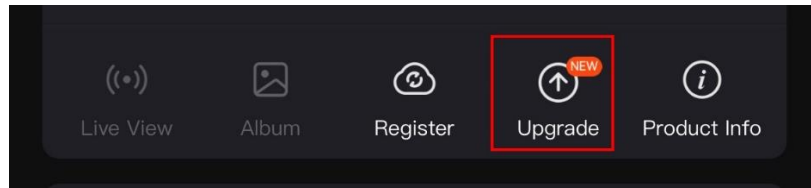

Figure 2-15 Check Firmware Status

3. (Optional) If the firmware is not the latest version, upgrade the device. See *Upgrade Device*.

2.9.2 Upgrade Device

Upgrade Device via HIKMICRO Sight

Steps

1. Open HIKMICRO Sight app and connect your device to the app.
2. Tap the upgrade prompt to enter the firmware upgrade interface.
3. Tap **Upgrade** to start upgrade.



Note

The upgrading operation may vary due to app updates. Please take the actual app version for reference.

Upgrade Device via PC

Before You Start

Please get the upgrade package first.

Steps

1. Connect the device to your PC with cable.
 2. Open the detected disk, copy the upgrade file and paste it to the root directory of the device.
 3. Disconnect the device from your PC.
 4. Reboot the device, and the device upgrades automatically. The upgrading process will be displayed in the main interface.
-



Caution

During the upgrade package transmission, make sure the device is connected to your PC. Otherwise, it may cause unnecessary upgrade failure, firmware damage, etc.

2.10 Zeroing

You can enable the reticle to view the position of the target. Functions such as freeze and zoom help to adjust the reticle more accurately. See *Zeroing* for detailed instructions.

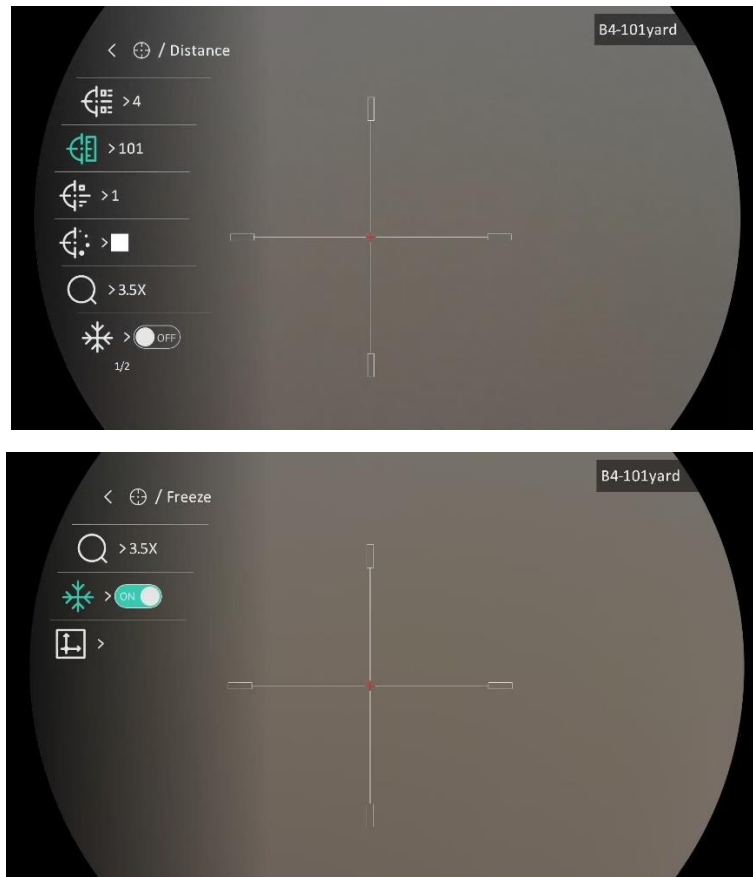

Figure 2-16 Zeroing

3 Image Settings

3.1 Adjust Diopter

Steps

1. Power on the device.
2. Open the lens cover.
3. Hold the device and make sure the eyepiece covers your eye.
4. Adjust the diopter adjustment ring until the OSD information or image is clear.

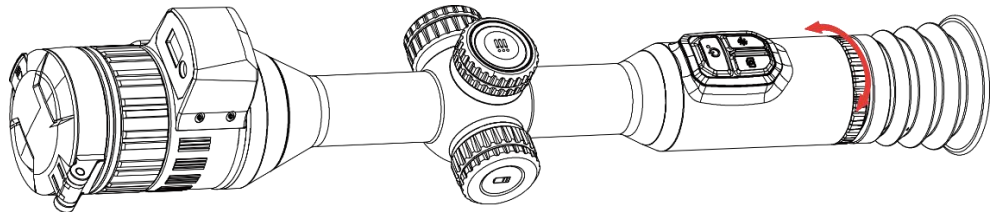

Figure 3-1 Adjust Diopter



Note

When adjusting diopter, DO NOT touch the surface of lens to avoid smearing the lens.

3.2 Adjust Focus

Steps

1. Power on the device.
2. Hold the device and make sure the eyepiece covers your eye.
3. Adjust the focus ring until the image is clear.

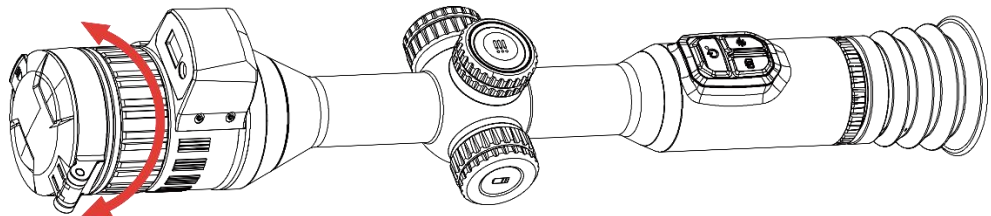

Figure 3-2 Adjust Focus



Note

When focusing, do not touch the surface of lens to avoid smearing the lens.

3.3 Adjust Aperture

Steps

1. Power on the device.
2. Hold the device and make sure the eyepiece covers your eye.
3. Rotate the aperture adjustment ring to adjust aperture to accommodate various light conditions.

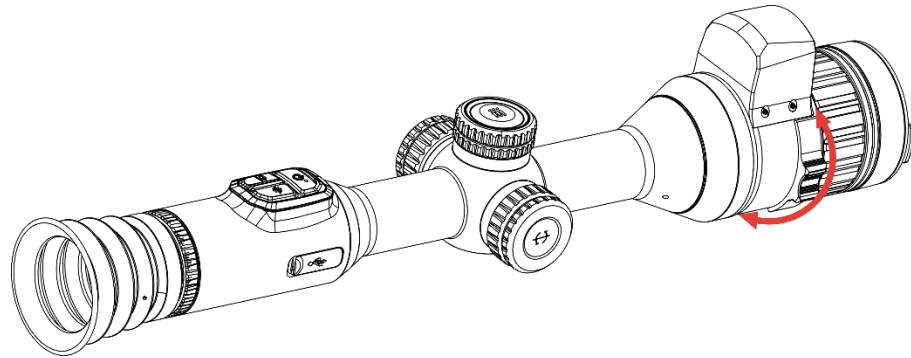



Figure 3-3 Adjust Aperture

3.4 Adjust Brightness

You can adjust the display brightness of the screen in the menu.

Steps

1. Hold the wheel to show the menu.
2. Rotate the wheel to select  and press the wheel to confirm.
3. Rotate the wheel to adjust brightness.
4. Hold the wheel to save settings and exit.

3.5 Adjust Contrast

Steps

1. Hold the wheel to show the menu.

2. Rotate the wheel to select  and press the wheel to confirm.
3. Rotate the wheel to adjust contrast.
4. Hold the wheel to save settings and exit.

3.6 Switch Day and Night

You can select different display modes in different scenes.

Steps

1. Hold the wheel to show the menu.
2. Rotate the wheel to select  and press the wheel to confirm.

Rotate the wheel to switch display modes. Day, night and auto modes are selectable.

- : Day mode. You can use this mode at daytime and in bright environment.



Figure 3-4 Day Mode



- : Night mode. You can use this mode at night.



Figure 3-5 Night Mode



- : Auto mode. The day mode and night mode switch automatically according to the ambient brightness.

3. Hold the wheel to save settings and exit.

3.7 Set Smart IR

Image overexposure may occur in too bright environment. The smart IR function helps to adjust the overexposed images by controlling infrared light intensity, so as to improve the image effect in night mode and dark environment.

Steps

1. Hold the wheel to show the menu.
2. Go to  **Advanced Settings**, and rotate the wheel to select .
3. Press the wheel to enable the function.
4. Hold the wheel to save settings and exit.

3.8 Set Picture in Picture Mode

In the live view interface, hold  to turn on/off PIP.

- When reticle is enabled, the PIP view is the detail of reticle.
- When reticle is not enabled, the PIP view is the detail of central part.



Figure 3-6 PIP





Note

If the PIP function is enabled, only the PIP view zooms when adjusting the digital zoom ratio.

3.9 Adjust Digital Zoom

In the live view interface, rotate the wheel to adjust digital zoom of the device.

Steps

1. Hold the wheel to show the menu.
2. Go to  **Advanced Settings**, and rotate the wheel to select .
3. Press the wheel to enter the setting interface, and rotate the wheel to select a zoom mode.
 - **Multiple:** The digital zoom ratio can be set to 1×, 2×, 4×, and 8×.
 - **Continuous:** The digital zoom ratio can be set from 1.0× to 8.0× continuously.
4. Hold the wheel to save and exit.
5. In the live view interface, rotate the wheel to switch the digital zoom of the device.



Note

When switching the digital zoom ratio, the left interface displays the actual magnification (Actual Magnification = Lens Optical Magnification × Digital Zoom Ratio). For example, the lens optical magnification is 2.8× and the digital zoom ratio is 2×, and the actual magnification is 5.6×.

3.10 Set Pitch Scale

You can enable pitch scale to view the device inclination angle in the live view.

Steps



1. Hold the wheel to show the menu.
2. Go to  **Advanced Settings**, and select  **Function Settings**.
3. Rotate the wheel to select  , and press the wheel to enable the pitch scale.
4. Hold the wheel to save and exit.





Figure 3-7 Pitch Scale

4 Zeroing

4.1 Set Reticle Mode

You can select a reticle mode according to your preference and different situations.

Steps

1. Hold the wheel to show the menu.
2. Go to  **Advanced Settings**, and rotate the wheel to select .
3. Press the wheel to enter the setting interface, and rotate the wheel to select a reticle mode.
 - **Central Reticle:** This mode centers around the image when switching the digital zoom ratio, with the reticle position unchanged.
 - **Fixed Reticle:** This mode centers around the reticle when switching the digital zoom ratio.
4. Hold the wheel to save and exit.





Note

- The digital zoom ratio returns to 1× when switching the reticle mode.
 - If you select fixed reticle, the continuous zoom ratio can be set from 1.0× to 8.0×.
 - If you select central reticle, the continuous zoom ratio can be set from 2.0× to 8.0×.
-

4.2 Select Zeroing Profile

You can configure and save the reticle settings in zeroing profiles according to various situation.

Steps

1. Hold the wheel to show the menu.
2. Go to  **Advanced Settings**, and rotate the wheel to select .
3. Rotate the wheel to select a zeroing profile.
4. Hold the wheel to save and exit.

Result

The right top of the image displays the reticle information. For example, B4-101yard means you are using the No. 4 reticle in zeroing profile B, and the set distance is 101 yard.

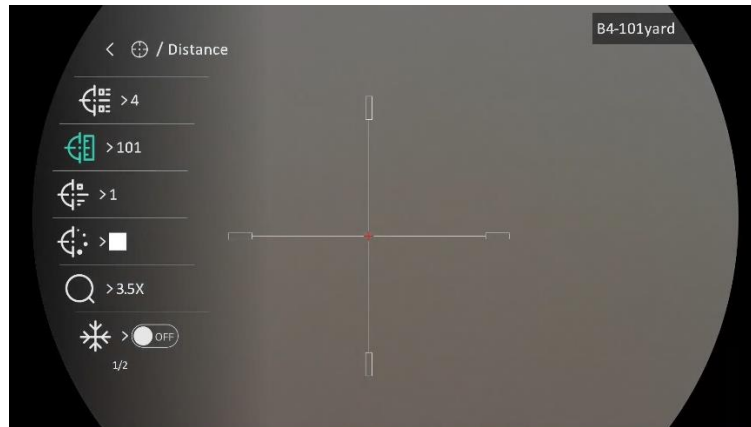

Figure 4-1 Using a Reticle



Note

There are 5 zeroing profiles in total, and you can configure 5 reticles in each zeroing profile.





4.3 Set Reticle

You can select a reticle in the current zeroing profile, and set parameters such as type, color, and position for the reticle.

Before You Start

Select a zeroing profile first.

Steps

1. Hold the wheel to show the menu.
2. Go to  **Advanced Settings**, and rotate the wheel to select  . Press the wheel to enter the setting interface.
3. Select  **Zeroing**, and press the wheel to confirm. Rotate the wheel to select a reticle No. You can select **OFF** to turn off the reticle.
4. Select  **Type**, and press the wheel to confirm. Rotate the wheel to select the reticle type. 10 types of reticles can be selected.

5. Select  **Color**, and press the wheel to confirm. Rotate the wheel to set the reticle color.
6. (Optional) Repeat 3 to 5 to set other reticles in this zeroing profile.



Note

When you switch the reticle No., a prompt will appear on the interface. Select **OK** to save the parameters for the current reticle.

7. Hold the wheel to exit according to the prompt.
 - **OK**: Save the parameter and exit.
 - **CANCEL**: Exit and not save the parameters.



Note

- 5 reticles can be configured in a zeroing profile.
 - If the PIP function is enabled, the aimed target can be magnified on the interface.
 - In black hot mode and white hot mode, if you set the reticle color as white or black, the color of the reticle will be inverted automatically to better aim at the target.
-

4.4 Correct Reticle



Correcting the reticle can help you aim at the target with high accuracy by marking the offset between the big reticle and small reticle. Functions such as **Freeze** and **Zoom** help to adjust the reticle more accurately.

4.4.1 Correct Reticle on Device

Before You Start

Select a zeroing profile first.

Steps

1. Hold the wheel to show the menu.
2. Go to  **Advanced Settings**, and rotate the wheel to select  . Press the wheel to enter the setting interface.
3. Select  **Zeroing**, and press the wheel to confirm. Rotate the wheel to select a reticle you want to correct.

4. Set the distance to the target.

- 1) Rotate the wheel to select  **Distance**.
- 2) Press the wheel to select the number you want to change.
- 3) Rotate the wheel to change the number, and press the wheel to finish the setting.

5. Select  **Zoom**, and press the wheel to confirm. Rotate the wheel to set the digital zoom ratio.

6. Aim at the target and pull the trigger. Align the reticle with the point of impact.

- 1) Aim the big reticle at the target.
- 2) Select  **Freeze**. Press the wheel to enable the function.
- 3) Rotate the wheel to set the coordinates until the big reticle aligns with the point of impact. Press the wheel to select axis. If you select **X**, the reticle moves left and right; if you select **Y**, the reticle moves up and down. Hold the wheel to finish setting.



Figure 4-2 Enable Freeze



Note

- When you switch the reticle No., a prompt will appear on the interface. Select **OK** to save the parameters for the current reticle.
 - When enabling the freeze function in reticle, you can adjust the position of the cursor on a frozen image. This function can prevent image flutter.
-

7. Hold the wheel to exit the setting interface according to the prompt.
 - **OK**: Save the parameter and exit.
 - **CANCEL**: Exit but not save the parameters.
8. Pull the trigger again to verify that the aiming point aligns with the point of impact.
9. (Optional) Repeat 3 to 8 to set the position for other reticles in this zeroing profile.

4.4.2 Correct Reticle via HIKMICRO Sight

You can also correct the reticle by HIKMICRO Sight app.

Before You Start

Install HIKMICRO Sight on your phone.

Step

1. Open HIKMICRO Sight and connect your device to the app.
2. Tap **Product Info**, and tap **Zero** to enter configuration interface.
3. Set reticle to the target.
 - 1) After synchronizing data from the device, select a zeroing profile.
 - 2) Select a reticle you want to correct.
 - 3) Input the number to set the distance to the target.
 - 4) Select digital zoom ratio.
4. After synchronizing parameters to the device, aim at the target and pull the trigger.
5. Measure the deviation of the point of impact from the target, and input the number to adjust the position of reticle until the big reticle aligns with the point of impact.
6. (Optional) Tap **Next Profile** for to set the position for other reticles.

Result

The position of the reticle is saved and synchronized to your device, so you can check it on your device.



Note

- When you enter the zeroing setting interface on your app, the device will return to the live view interface automatically.
 - The zeroing operation may vary due to app updates. Please take the actual app version for reference.
-



5 Measure Distance

The device can detect the distance between the target and the observation position with laser.

Before You Start

When measuring the distance, keep the hand and the position steady. Otherwise, the accuracy may be affected.

Steps

1. Hold the wheel to show the menu.
2. Go to  **Advanced Settings**, and rotate the wheel to select  .
Press the wheel to enter the setting interface.
3. Rotate the wheel to select a continuous laser ranging mode. Press the wheel to confirm.



Note

The device can measure the distance continuously, and the measurement duration can be selected. The measurement result will be refreshed every 1 s.

4. Hold the wheel to save the setting and return to the live view interface.
5. Aim the cursor at the target and press  to measure the target distance.



Note

- Press  in the live view interface to turn off laser ranging.
- Laser ranging cannot be enabled when device battery is low.

Result

The right top of the image displays the distance measurement result.



Caution

The laser radiation emitted from the device can cause eye injuries, burning of skin or inflammable substances. Before enabling the laser ranging function, make sure no human or inflammable substances are in front of the laser lens.





6 Ballistic Calculation for Hunting

The ballistic calculation helps you have a better experience in various conditions. Multiple parameters are required in calculation to ensure precision and flexibility of use.

Before You Start

- Make sure the **Ballistic Calculation** switch is on.
- Make sure the reticle is enabled.
- Make sure you have finished zeroing.

Steps

1. Hold the wheel to show the menu.
2. Go to  **Advanced Settings**, and rotate the wheel to select  . Press the wheel to enter the setting interface.
3. Rotate the wheel to select **Ballistic Profile**, and press the wheel to switch the profile. You can configure and save the settings in respective profiles.
4. Rotate the wheel to select the following parameters, and press the wheel to input the data.
 - Initial Velocity: The velocity varies in different conditions.
 - Zero Range: The range you have zeroed the device at.
 - Ballistic Coefficient: The measure of its ability to overcome air resistance.
 - Sight Height: The distance between the bore and the center of the lens.
 - Altitude: Set this to your normal altitude.
 - Temperature: Set this to your normal temperature.
5. Press the wheel to switch digit, and rotate the wheel to change the number.
6. Hold the wheel to save and exit.
7. Aim the cursor at the target and press  to measure the target distance. The screen will display the recommended aiming point  and the drop distance in the upper right corner of the interface.

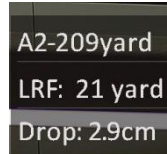

Figure 6-1 Drop Distance

8. (Optional) To adjust distance, repeat the above step.



Note



- 5 ballistic profiles can be saved.
 - The more parameters you specify, the more accurate the recommended aiming point will be.
 - The drop distance is related to the input parameters. Please refer to the actual situation.
-

7 General Settings

7.1 Set OSD

This function can display or hide the OSD information on the live view interface.

Steps

1. Hold the wheel to show the menu.
2. Go to  **Advanced Settings**, and select  **Function Settings**.
3. Rotate the wheel to select  , and press the wheel to enter OSD setting interface.
4. Rotate the wheel to select the **Time, Date, or OSD**, and press the wheel to turn on or turn off the selected OSD information.
5. Hold the wheel to save and exit.





Note

If you turn off **OSD**, all OSD information on the live view will not be displayed.

7.2 Set Brand Logo

You can add brand logo to the live view interface, snapshots, and videos.

Steps

1. Hold the wheel to show the menu.
2. Go to  **Advanced Settings**, and select  **Function Settings**.
3. Rotate the wheel to select  .
4. Press the wheel to enable **Brand Logo**.
5. Hold the wheel to save the settings and exit.

Result

The brand logo is displayed at the bottom left of the image.



Figure 7-1 Brand Logo Display

7.3 Capture and Video

7.3.1 Capture Picture

In the live view interface, press  to capture picture.





Note

- When capturing succeeds, the image freezes for 1 second and a prompt shows on the display.
 - For exporting pictures, refer to *Export Files*.
-

7.3.2 Set Audio

If you turn on the audio function, the sound will be recorded with the video. When there is too loud noise in the video, you can turn off this function.

Steps

1. Hold the wheel to show the menu.
2. Go to  **Advanced Settings**, and rotate the wheel to select .
3. Press the wheel to enable or disable this function.
4. Hold the wheel to save settings and exit.

7.3.3 Record Video

Steps



1. In the live view interface, hold  to start recording.



Figure 7-2 Start Recording



The left image displays the information of recording time.

2. Hold  again to stop recording.

7.3.4 Prerecord Video

After you enable this function and select the prerecording time, the device can automatically start recording the 7, 10 or 15 seconds before the recoil-activation and end recording the 7, 10 or 15 seconds after the recoil-activation.

Steps

1. Hold the wheel to show the menu.
2. Go to  **Advanced Settings**, and rotate the wheel to select .
3. Press the wheel to enter the setting interface. Rotate the wheel to switch the prerecording time. 7 s, 10 s, and 15 s are selectable. You can also select **OFF** to turn off the function.
4. Hold the wheel to save settings and exit.

7.3.5 View Local Files

Captured images and recorded videos are automatically stored in the device, and you can view the files in local albums.

Steps

1. Hold the wheel to show the menu.
2. Rotate the wheel to select . Press the wheel to enter the album.





Note

The albums are automatically created and named by year + month. The local pictures and videos of a certain month are stored in the corresponding album. For example, the pictures and videos of August in 2023 are saved in the album named 202308.

3. Rotate the wheel to select the album, and press the wheel to enter the selected album.
 4. Rotate the wheel to select a file to view.
 5. Press the wheel to view the selected file and relevant information.
-



Note

- Files are arranged in chronological order, with the most recent at the top. If you fails to find the most recently taken snapshots or videos, please check the time and date settings of your device. When you are viewing files, you can switch to other files by rotating the wheel.
 - When you are viewing videos, you can press the wheel to play or stop the video.
 - For deleting an album or a file, you can press  +  to call the dialogue box, and delete the album or file according to the prompt.
-

7.4 Export Files

7.4.1 Export Files via HIKMICRO Sight

You can access device albums and export files to your phone via HIKMICRO Sight.

Before You Start

Install HIKMICRO Sight on your mobile phone.

Steps

1. Open HIKMICRO Sight and connect your device to the app. See *App Connection*.
2. Tap **Media** to access device albums.

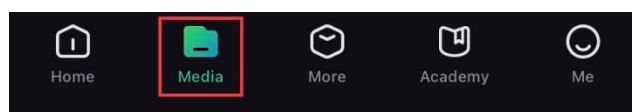

Figure 7-3 Figure 5-3 Access Device Albums

3. Tap **Local** or **Device** to view the photos and videos.
 - **Local**: You can view the files captured on app.
 - **Device**: You can view the files of the current device.



Note

The photos or videos may not show in **Device**. Please pull down to refresh the page.

4. Tap to select a file, and tap **Download** to export the file to your local phone albums.



Figure 7-4 Export Files



Note

- Go to **Me -> About -> User Manual** on the app to see more detailed operations.
 - You can also access device albums by tapping bottom left icon in the live view interface.
 - The exporting operation may vary due to app updates. Please take the actual app version for reference.
-

7.4.2 Export Files via PC

This function is used to export recorded videos and captured pictures.

Before You Start

Make sure the device is turned on when connecting the cable.

Steps

1. Connect the device and PC with cable.
-



Note

Make sure the device is turned on when connecting the cable.

2. Open computer disk and select the disk of device. Go to the DCIM folder and find the folder named after the capture year and month. For example, if you capture a picture or record a video on June 2023, go to **DCIM -> 202306** to find the picture or video.

3. Select and copy the files to PC.
4. Disconnect the device from your PC.





Note

- The device displays images when you connect it to PC. But functions such as recording, capturing and hotspot are disabled.
 - When you connect the device to PC for the first time, it installs the drive program automatically.
-

8 System Settings



8.1 Adjust Date

Steps

1. Hold the wheel to show the menu.
2. Go to  **Advanced Settings**, and select  **General Settings**.
3. Rotate the wheel to select , and press the wheel to enter the configuration interface.
4. Press the wheel to select the year, month, or day, and rotate the wheel to change the number.
5. Hold the wheel to save settings and exit.

8.2 Synchronize Time

Step



1. Hold the wheel to show the menu.
2. Go to  **Advanced Settings**, and select  **General Settings**.
3. Rotate the wheel to select , and press the wheel to enter the configuration interface.
4. Rotate the wheel to switch the clock system. 24-hour and 12-hour clock are selectable. If you select 12-hour clock, press the wheel, and then rotate the wheel to select AM or PM.
5. Press the wheel to select the hour or minute, and rotate the wheel to change the number.
6. Hold the wheel to save settings and exit.

8.3 Set Language

You can select the device language in this function.

Steps



1. Hold the wheel to show the menu.

2. Go to  **Advanced Settings**, and select  **General Settings**.
3. Rotate the wheel to select  , and press the wheel to enter the configuration interface.
4. Rotate the wheel to select the language as required, and press the wheel to confirm.
5. Hold the wheel to save settings and exit.

8.4 Set Unit



You can switch the unit for distance measurement.

Steps

1. Hold the wheel to show the menu.
2. Go to  **Advanced Settings**, and select  **General Settings**.
3. Rotate the wheel to select  , and press the wheel to enter the configuration interface.
4. Rotate the wheel to select the unit as required.
5. Hold the wheel to save settings and exit.

8.5 View Device Information



Steps

1. Hold the wheel to show the menu.
2. Go to  **Advanced Settings**, and select  **General Settings**.
3. Rotate the wheel to select  , and press the wheel to confirm. You can view the device information such as version and serial No.
4. Hold the wheel to save settings and exit.

8.6 Restore Device

Steps

1. Hold the wheel to show the menu.

2. Go to  **Advanced Settings**, and select  **General Settings**.
3. Rotate the wheel to select  . Press the wheel to restore the device to defaults according to the prompt.

9 Frequently Asked Questions

9.1 Why is the monitor off?

- Check whether the device is off-battery.
- Check the monitor after charging the device for 5 minutes.

9.2 The image is not clear, how to adjust it?

Adjust the diopter adjustment ring or focus ring until the image is clear.
Refer to *Adjust Diopter* or *Adjust Focus*.

9.3 Capturing or recording fails. What's the problem?

Check the following items.

- Whether the device is connected to your PC. Capturing or recording is disabled in this status.
- Whether the storage space is full.
- Whether the device is low-battery.

9.4 Why the PC cannot identify the device?

Check the following items.

- Whether the device is connected to your PC with supplied USB cable.
- If you use other USB cables, make sure the cable length is no longer than 1 m.

Legal Information

©2023 Hangzhou Microimage Software Co., Ltd. All rights reserved.

About this Manual

The Manual includes instructions for using and managing the Product. Pictures, charts, images and all other information hereinafter are for description and explanation only. The information contained in the Manual is subject to change, without notice, due to firmware updates or other reasons. Please find the latest version of this Manual at the HIKMICRO website (www.hikmicrotech.com/).

Please use this Manual with the guidance and assistance of professionals trained in supporting the Product.

Trademarks Acknowledgement



and other HIKMICRO's trademarks and logos are the properties of HIKMICRO in various jurisdictions.

Other trademarks and logos mentioned are the properties of their respective owners.

LEGAL DISCLAIMER

TO THE MAXIMUM EXTENT PERMITTED BY APPLICABLE LAW, THIS MANUAL AND THE PRODUCT DESCRIBED, WITH ITS HARDWARE, SOFTWARE AND FIRMWARE, ARE PROVIDED "AS IS" AND "WITH ALL FAULTS AND ERRORS". HIKMICRO MAKES NO WARRANTIES, EXPRESS OR IMPLIED, INCLUDING WITHOUT LIMITATION, MERCHANTABILITY, SATISFACTORY QUALITY, OR FITNESS FOR A PARTICULAR PURPOSE. THE USE OF THE PRODUCT BY YOU IS AT YOUR OWN RISK. IN NO EVENT WILL HIKMICRO BE LIABLE TO YOU FOR ANY SPECIAL, CONSEQUENTIAL, INCIDENTAL, OR INDIRECT DAMAGES, INCLUDING, AMONG OTHERS, DAMAGES FOR LOSS OF BUSINESS PROFITS, BUSINESS INTERRUPTION, OR LOSS OF DATA, CORRUPTION OF SYSTEMS, OR LOSS OF DOCUMENTATION, WHETHER BASED ON BREACH OF CONTRACT, TORT (INCLUDING NEGLIGENCE), PRODUCT LIABILITY, OR OTHERWISE, IN CONNECTION WITH THE USE OF THE PRODUCT, EVEN IF HIKMICRO HAS BEEN ADVISED OF THE POSSIBILITY OF SUCH DAMAGES OR LOSS.

YOU ACKNOWLEDGE THAT THE NATURE OF THE INTERNET PROVIDES FOR INHERENT SECURITY RISKS, AND HIKMICRO SHALL NOT TAKE ANY RESPONSIBILITIES FOR ABNORMAL OPERATION, PRIVACY LEAKAGE OR OTHER DAMAGES RESULTING FROM CYBER-ATTACK, HACKER ATTACK, VIRUS INFECTION, OR OTHER INTERNET SECURITY RISKS; HOWEVER, HIKMICRO WILL PROVIDE TIMELY TECHNICAL SUPPORT IF REQUIRED.

YOU AGREE TO USE THIS PRODUCT IN COMPLIANCE WITH ALL APPLICABLE LAWS, AND YOU ARE SOLELY RESPONSIBLE FOR ENSURING THAT YOUR USE CONFORMS TO THE APPLICABLE LAW. ESPECIALLY, YOU ARE RESPONSIBLE, FOR USING THIS PRODUCT IN A MANNER THAT DOES NOT INFRINGE ON THE RIGHTS OF THIRD PARTIES, INCLUDING WITHOUT LIMITATION, RIGHTS OF PUBLICITY, INTELLECTUAL PROPERTY RIGHTS, OR DATA PROTECTION AND OTHER PRIVACY RIGHTS. YOU SHALL NOT USE THIS PRODUCT FOR ILLEGAL HUNTING ANIMALS, INVASION OF PRIVACY OR ANY OTHER PURPOSE WHICH IS ILLEGAL OR DETRIMENTAL TO THE PUBLIC INTEREST. YOU SHALL NOT USE THIS PRODUCT FOR ANY PROHIBITED END-USES, INCLUDING THE DEVELOPMENT OR PRODUCTION OF WEAPONS OF MASS DESTRUCTION, THE DEVELOPMENT OR PRODUCTION OF CHEMICAL OR BIOLOGICAL WEAPONS, ANY ACTIVITIES IN THE CONTEXT RELATED TO ANY NUCLEAR EXPLOSIVE OR UNSAFE NUCLEAR FUEL-CYCLE, OR IN SUPPORT OF HUMAN RIGHTS ABUSES.

PLEASE FOLLOW ALL THE PROHIBITIONS AND EXCEPTIONAL CAVEATS OF ALL APPLICABLE LAWS AND REGULATIONS, IN PARTICULAR, THE LOCAL FIREARMS AND/OR HUNTING LAWS AND REGULATIONS. PLEASE ALWAYS CHECK NATIONAL PROVISIONS AND REGULATIONS BEFORE PURCHASE OR USE OF THIS PRODUCT. PLEASE NOTE THAT YOU MAY HAVE TO APPLY FOR PERMITS, CERTIFICATES, AND/OR LICENSES BEFORE ANY PURCHASING, SELLING, MARKETING AND/OR USING OF THE PRODUCT. HIKMICRO SHALL NOT BE LIABLE FOR ANY SUCH ILLEGAL OR IMPROPER PURCHASING, SELLING, MARKETING, AND END USES AND ANY SPECIAL, CONSEQUENTIAL, INCIDENTAL, OR INDIRECT DAMAGES ARISING THEREOF.

IN THE EVENT OF ANY CONFLICTS BETWEEN THIS MANUAL AND THE APPLICABLE LAW, THE LATTER PREVAILS.

Regulatory Information

These clauses apply only to the products bearing the corresponding mark or information.

EU Conformity Statement



This product and - if applicable - the supplied accessories too are marked with "CE" and comply therefore with the applicable harmonized European standards listed under the Directive 2014/30/EU (EMCD), Directive 2014/35/EU (LVD), Directive 2011/65/EU (RoHS), Directive 2014/53/EU.

Hereby, Hangzhou Microimage Software Co., Ltd. declares that this device (refer to the label) is in compliance with Directive 2014/53/EU.

The full text of the EU declaration of conformity is available at the following internet address:

<https://www.hikmicrotech.com/en/support/download-center/declaration-of-conformity/>

Frequency Bands and Power (for CE)

The frequency bands and transmitting power (radiated and/or conducted) nominal limits applicable to the following radio equipment are as follows:

Wi-Fi 2.4 GHz (2.4 GHz to 2.4835 GHz), 20 dBm

For the device without a supplied power adapter, use the power adapter provided by a qualified manufacturer. Refer to the product specification for detailed power requirements.

For the device without a supplied battery, use the battery provided by a qualified manufacturer. Refer to the product specification for detailed battery requirements.



Directive 2012/19/EU (WEEE Directive): Products marked with this symbol cannot be disposed of as unsorted municipal waste in the European Union. For proper recycling, return this product to your local supplier upon the purchase of equivalent new equipment, or dispose of it at designated collection points. For more information see: www.recyclethis.info



Directive 2006/66/EC and its amendment 2013/56/EU (Battery Directive): This product contains a battery that cannot be disposed of as unsorted municipal waste in the European Union. See the product documentation for specific battery information. The battery is marked with this symbol, which may include lettering to indicate cadmium (Cd), lead (Pb), or mercury (Hg). For proper recycling, return the battery to your supplier or to a designated collection point. For more information see: www.recyclethis.info.

Industry Canada ICES-003 Compliance

This device meets the CAN ICES-003 (B)/NMB-003(B) standards requirements.

This device complies with Industry Canada license-exempt RSS standard(s). Operation is subject to the following two conditions:

- (1) this device may not cause interference, and
- (2) this device must accept any interference, including interference that may cause undesired operation of the device.

This equipment complies with IC RSS-102 radiation exposure limits set forth for an uncontrolled environment.

Conformité Industrie Canada ICES-003

Cet appareil répond aux exigences des normes CAN ICES-003 (B)/NMB-003 (B).

Cet appareil est conforme aux normes RSS exemptes de licence d'Industrie Canada. Son fonctionnement est soumis aux deux conditions suivantes:

- (1) cet appareil ne doit pas causer d'interférences, et
- (2) cet appareil doit accepter toute interférence reçue, notamment les interférences susceptibles d'occasionner un fonctionnement indésirable de l'appareil.

Cet appareil est conforme aux limites d'exposition au rayonnement IC RSS-102 établies pour un environnement non contrôlé.

INFORMATIONEN FÜR PRIVATE HAUSHALTE

1. Getrennte Erfassung von Altgeräten:

Elektro- und Elektronikgeräte, die zu Abfall geworden sind, werden als Altgeräte bezeichnet. Besitzer von Altgeräten haben diese einer vom unsortierten Siedlungsabfall getrennten Erfassung zuzuführen. Altgeräte gehören insbesondere nicht in den Hausmüll, sondern in spezielle Sammel- und Rückgabesysteme.

2. Batterien und Akkus sowie Lampen:

Besitzer von Altgeräten haben Altbatterien und Altakkumulatoren, die nicht vom Altgerät umschlossen sind, die zerstörungsfrei aus dem Altgerät entnommen werden können, im Regelfall vor der Abgabe an einer Erfassungsstelle vom Altgerät zu trennen. Dies gilt nicht, soweit Altgeräte einer Vorbereitung zur Wiederverwendung unter Beteiligung eines öffentlich-rechtlichen Entsorgungsträgers zugeführt werden.

3. Möglichkeiten der Rückgabe von Altgeräten:

Besitzer von Altgeräten aus privaten Haushalten können diese bei den Sammelstellen der öffentlich-rechtlichen Entsorgungsträger oder bei den von Herstellern oder Vertriebern im Sinne des ElektroG eingerichteten Rücknahmestellen unentgeltlich abgeben. Rücknahmepflichtig sind Geschäfte mit einer Verkaufsfläche von mindestens 400 m² für Elektro- und Elektronikgeräte sowie diejenigen Lebensmittelgeschäfte mit einer Gesamtverkaufsfläche von mindestens 800 m², die mehrmals pro Jahr oder dauerhaft Elektro- und Elektronikgeräte anbieten und auf dem Markt bereitstellen. Dies gilt auch bei Vertrieb unter Verwendung von Fernkommunikationsmitteln, wenn die Lager- und Versandflächen für Elektro- und Elektronikgeräte mindestens 400 m² betragen oder die gesamten Lager- und Versandflächen mindestens 800 m² betragen. Verreiber haben die Rücknahme grundsätzlich durch geeignete Rückgabemöglichkeiten in zumutbarer Entfernung zum jeweiligen Endnutzer zu gewährleisten. Die Möglichkeit der unentgeltlichen Rückgabe eines Altgerätes besteht bei rücknahmepflichtigen Verreibern unter anderem dann, wenn ein neues gleichartiges Gerät, das im Wesentlichen die gleichen Funktionen erfüllt, an einen Endnutzer abgegeben wird.

4. Datenschutz-Hinweis:

Altgeräte enthalten häufig sensible personenbezogene Daten. Dies gilt insbesondere für Geräte der Informations- und Telekommunikationstechnik wie Computer und Smartphones. Bitte beachten Sie in Ihrem eigenen Interesse, dass für die Löschung der Daten auf den zu entsorgenden Altgeräten jeder Endnutzer selbst verantwortlich ist.



5. Bedeutung des Symbols „durchgestrichene Mülltonne“:



Das auf Elektro- und Elektronikgeräten regelmäßig abgebildete Symbol einer durchgestrichenen Mülltonne weist darauf hin, dass das jeweilige Gerät am Ende seiner Lebensdauer getrennt vom unsortierten Siedlungsabfall zu erfassen ist.

Symbol Conventions

The symbols that may be found in this document are defined as follows.

Symbol	Description
 Note	Provides additional information to emphasize or supplement important points of the main text.
 Caution	Indicates a potentially hazardous situation, which if not avoided, could result in equipment damage, data loss, performance degradation, or unexpected results.
 Danger	Indicates a hazard with a high level of risk, which if not avoided, will result in death or serious injury.

Safety Instruction

These instructions are intended to ensure that user can use the product correctly to avoid danger or property loss. Please read all the safety information carefully before using.

Transportation

- Keep the device in original or similar packaging while transporting it.
- Keep all wrappers after unpacking them for future use. In case of any failure occurred, you need to return the device to the factory with the original wrapper. Transportation without the original wrapper may result in damage on the device and the company shall not take any responsibilities.
- Do not drop the product or subject it to physical shock. Keep the device away from magnetic interference.

Power Supply

- The input voltage for the device should meet the Limited Power Source (5 VDC, 2 A) according to the IEC61010-1 standard. Please refer to actual products and technical specifications for detailed information.
- Make sure the plug is properly connected to the power socket.
- DO NOT connect multiple devices to one power adapter, to avoid overheating or fire hazards caused by overload.
- The power source should meet limited power source or PS2 requirements according to IEC 62368-1 standard.

Battery

- The external rechargeable battery type is 18650, and the battery size should be 19 mm × 70 mm. The rated voltage is 3.6 VDC, and the battery capacity is 3200 mAh.
- The built-in battery type is rechargeable lithium-ion battery, and the battery size should be 23 mm × 67 mm. The rated voltage is 3.635 V, and the battery capacity is 3350 mAh.
- For long-term storage of the battery, make sure it is fully charged every half year to ensure the battery quality. Otherwise, damage may occur.
- CAUTION: Risk of explosion if the battery is replaced by an incorrect type.
- The built-in battery cannot be dismantled. Please contact the manufacture for repair if necessary.

- Make sure the battery temperature is between 0°C to 45°C (32°F to 113°F) when charging.
- Improper replacement of the battery with an incorrect type may defeat a safeguard (for example, in the case of some lithium battery types).
- Do not dispose of the battery into fire or a hot oven, or mechanically crush or cut the battery, which may result in an explosion.
- Do not leave the battery in an extremely high temperature surrounding environment, which may result in an explosion or the leakage of flammable liquid or gas.
- Do not subject the battery to extremely low air pressure, which may result in an explosion or the leakage of flammable liquid or gas.
- Dispose of used batteries according to the instructions.
- Confirm there is no flammable material within 2 m of the charger during charging.
- DO NOT place the battery in the reach of children.
- DO NOT swallow the battery to avoid chemical burns.

Maintenance

- If the product does not work properly, please contact your dealer or the nearest service center. We shall not assume any responsibility for problems caused by unauthorized repair or maintenance.
- Wipe the device gently with a clean cloth and a small quantity of ethanol, if necessary.
- If the equipment is used in a manner not specified by the manufacturer, the protection provided by the device may be impaired.
- Clean the lens with soft and dry cloth or wiping paper to avoid scratching it.

Using Environment

- Make sure the running environment meets the requirement of the device. The operating temperature shall be -30 °C to 55 °C (-22 °F to 131 °F), and the operating humidity shall be from 5% to 95%.
- DO NOT expose the device to high electromagnetic radiation or dusty environments.
- DO NOT aim the lens at the sun or any other bright light.
- Place the device in a dry and well-ventilated environment.
- When any laser equipment is in use, make sure that the device lens is not exposed to the laser beam, or it may burn out.
- Avoid equipment installation on vibratory surface or places subject to shock (neglect may cause equipment damage).

Emergency

If smoke, odor, or noise arises from the device, immediately turn off the power, unplug the power cable, and contact the service center.

Laser

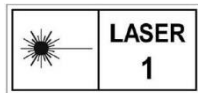

When any laser equipment is in use, make sure that the device lens is not exposed to the laser beam, or it may burn out. The laser radiation emitted from the device can cause eye injuries, burning of skin or inflammable substances. Before enabling the laser ranging function, make sure no human or inflammable substances are in front of the laser lens. Do not place the device where minors can fetch it. The wavelength is 905 nm, and the max. power output is less than 1.15 mW. According to IEC 60825-1:2014, this laser product is classified as Class 1 laser product.

Manufacture Address

Room 313, Unit B, Building 2, 399 Danfeng Road, Xixing Subdistrict,
Binjiang District, Hangzhou, Zhejiang 310052, China

Hangzhou Microimage Software Co., Ltd.



HIKMICRO

See the World in a New Way



Facebook: HIKMICRO Outdoor Instagram: hikmicro_outdoor

YouTube: HIKMICRO Outdoor

LinkedIn: HIKMICRO

Web: www.hikmicrotech.com

E-mail: support@hikmicrotech.com

UD35709B