

# **Tube Series User Manual**

**V1.0**

**IRay Technology Co. Ltd.**

## Specification:

Model	TL35
<b>Microbolometer</b>	
Type	Uncooled
Resolution, pixels	384x288
Pixel Size, um	12
NETD, mk	≤50
Frame Rate, Hz	50
<b>Optical Characteristics</b>	
Objective Lens, mm	35
Field of View, °	7.5x5.6
Magnification, x	3.0-12.0
E-zoom, x	1.0~ 4.0
Eye Relief, mm	70
Diopter Adjustment, D	-4 ~ +4
Detection Range, m (Target size:1.7m×0.5m, P(n)=99%)	1816
<b>Display</b>	
Type	LCOS
Resolution, pixels	1280x960
<b>Power Supply</b>	
Battery	Built-in two 18650 batteries and a replaceable 18500 battery
Max. Operating Time (at temp.=22 °C), h*	15
External power supply	5V (Type C USB)
<b>Operational Characteristics</b>	
Diameter of the riflescope body to assemble the mounting rings, mm	30
Max. Recoil Power on Rifled Weapon, g/s <sup>2</sup>	1000
Degree of protection, IP code	IP67
Amount of built-in memory, GB	16
Operating Temperature Range, °C	-20~+50
Weight (without replaceable battery), g	<950
Dimension, mm	385×85×75
USB Interface	Type-C

\* The actual operation time depends on the intensity of using Wi-Fi, Video-Recording and other functions;

- The device and software may update for perfection of the product;
- Current version of User Manual can be found in official website: [www.xinfrared.com](http://www.xinfrared.com).

## 1. Package List

- Tube series thermal Imaging Riflescope
- Eyeshade
- Mounting for Picatinny rail
- IPB-3 portable bag
- Type C cable
- Power adapter
- Cloth for lens wiping
- Certificate

## 2. Introduction

Tube series thermal imaging riflescopes are designed for use with hunting weapons no matter it's day or night, or at adverse weather conditions (rain, smog, fog, and etc.). Based on the principle of thermal imaging, thermal imaging riflescopes do not require external light source and are resistant to high-illumination level. With Tube series thermal imaging riflescopes, users can observe objectives even having the obstacles (branches, tall grass, dense bushes etc.).

With two power supply solutions for ultra-long operation duration, Tube series can be widely used for hunting, observation, locating in low visibility condition. Tube series is designed with the 30mm standard pipe diameter, meeting the universal fixture interface.

## 3. Features

- 12  $\mu$  m Independent developed detector
- High quality image
- Variable magnification
- Double power supply solutions, ultra-long operation duration
- Standard 30mm pipe diameter

- Stadia-metric rangefinder
- Long detection range
- High frame frequency: 50Hz
- Build-in storage, supports photographing and video recording
- Build-in WIFI module for connecting App
- Digital compass and gravity sensor
- Picture in Picture (PIP)
- Defect pixel correction
- User-friendly interface

## 4. Parts

1. Eyeshade
2. Eyepiece adjustment ring
3. Photo button
4. Brightness button
5. Power button
6. Palette button
7. Controller
8. USB cover
9. Type C port
10. LED indicator light
11. Extend battery cover
12. 18500 battery
13. Lens focus ring
14. Lens cover

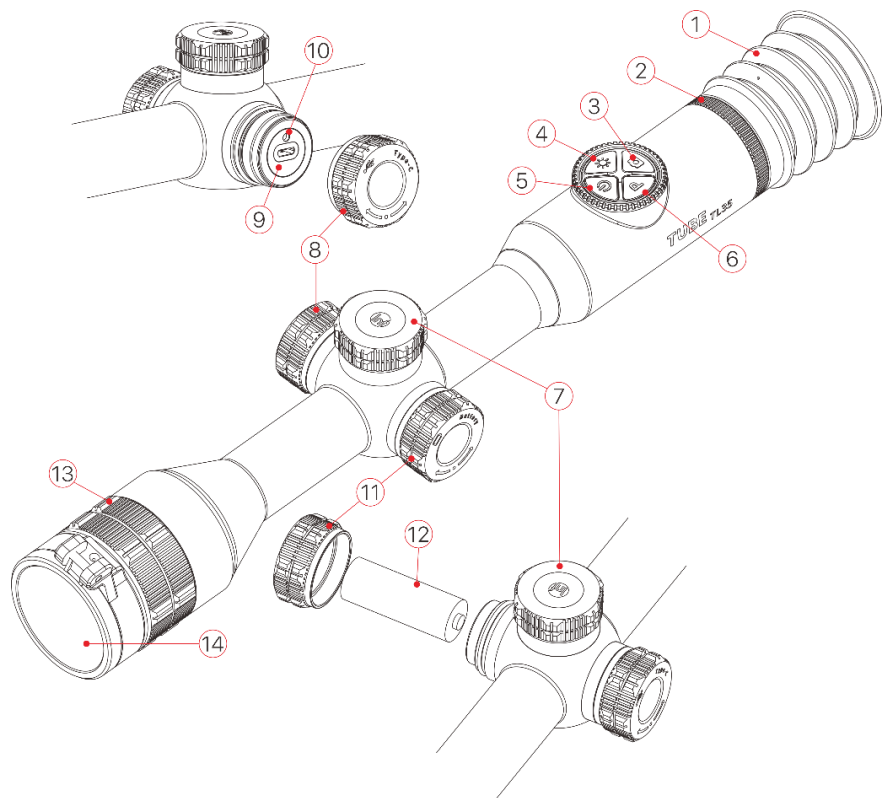

## 5. Functions of buttons

<b>Button</b>	<b>Status/Current Operation mode</b>	<b>Short Press</b>	<b>Long Press</b>	<b>Rotation</b>
<b>Power button</b>	Switched off	---	Switch on	---
	Home screen	calibration	Switch off/Standby	---
	Standby mode	Wake up the device	---	---
	Main menu	Exit to the previous menu without saving	---	---
	Pixel calibration	Add/Delete defect pixel	---	---
<b>Palette button</b>	Home screen	Switch the image palette	Switch PIP on/off	---
<b>Brightness button</b>	Home screen	Adjust screen brightness	Switch on/off Stadiametric Rangefinder	---
<b>Photography button</b>	Home screen	Take photograph	Start/Stop video recording	---
<b>Controller</b>	Home screen	Enter Shortcut Menu	Enter the Main Menu	Smooth zooming
	Shortcut menu	Adjust parameters	Save & Exit to the home screen	Switch menu options/Change reticle location:
	Main menu	Confirm	Save & Exit	



		selection, enter submenu	to Home Screen	Rotate clockwise: move left/down
	Pixel defect calibration/Zeroing g	Switch X/Y axis	Save & Exit to Home Screen	Rotate anti- clock wise: move right/up

## 6. Charging Battery

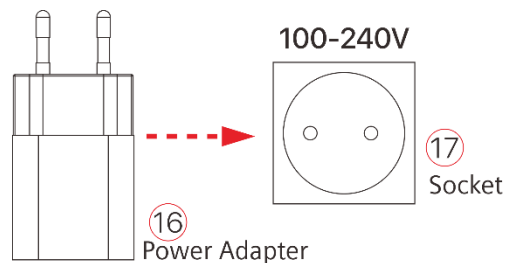
Tube series have double power supply solutions: built-in rechargeable li-ion battery pack and a replaceable 18500 battery, the whole system supports standard working time: 15 hours. Please ensure the battery is fully charged before first time using.



### Charging Built-in Battery Pack

- Open the USB cover (8) by turning it anti-clockwise.
- Plug in the Type-C cable (15) to the Type-C port (9) on Tube.
- Connect another port of Type-C cable (15) with the power adapter (16).
- Plug in the power adapter (16) into a 100-240V socket (17) for charging.
- When charging, there will be an icon in flash shape  appears in the icon of battery. Meanwhile the LED on device turns into red; when LED changed to green, indicates battery fully charged.
- While the icon turns into , means low battery, please charge in time to avoid battery over discharge, resulting in device aging.

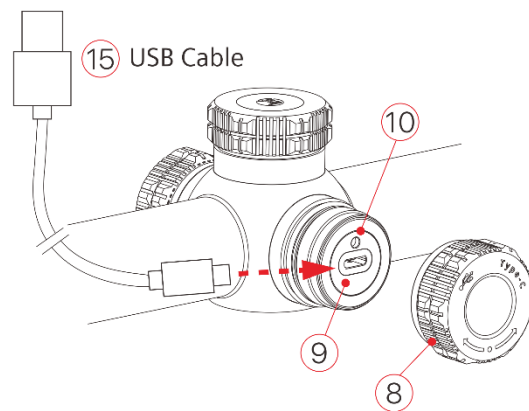

**Tips: Only the built-in battery pack will be charged while charging via USB port.**

## Installing 18500 battery

- Turn the battery cover (11) counterclockwise and remove it.
- Install one 18500 battery (12) into the battery compartment following the sign inside battery compartment, as anode electrode inward and negative electrode outward.
- Close the battery compartment cover (11) by turning it clockwise.

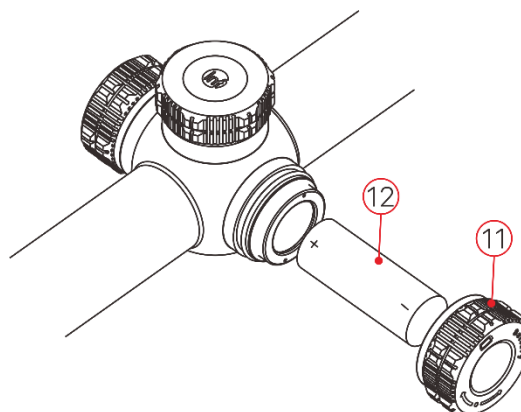

## Precautions

- Please charge with adapter as 5V2A in the package. Using other types of adapters may lead to irreversible damage to battery or adapter.
- If the device has been stored for a long time, it should be partial charged and should not be fully charged or completely discharge.
- When bringing the device from cold to warm environment, avoid charging instantly. Wait for 30-40 minutes so to warm up it.
- Avoid to use the charger which has been modified or damaged.
- Charge the scope at an air temperature range from 0°C to +40°C, otherwise the battery life will be reduced significantly.
- Please don't leave the device unattended while charging;
- Avoid leaving the device connected to the adapter for over 24 hours, after it has been fully charged;
- That is not recommended to connect with third device that has more power consumption than maximum.
- The device has short-circuited protection system. However, any situation that may cause short-circuiting should be avoided.
- The recommended operation temperature range is -20°C~+50°C. Avoid operating the device out of this temperature range, otherwise may shorten the battery life.
- When operating the device at subzero temperature, the capacity of battery decreases,

that is normal, not a defect.

## Switching Battery Power Supply

Tube series support double power supply system: Built-in li-ion battery pack and replaceable 18500 battery, also support USB port charging.

- If there are two batteries in Tube, two battery icons are displayed in the status bar ( the replaceable battery on the left while built-in battery on the right ). The battery from which the device is powered is displayed in green, and inactive is in gray.



- If there is no replaceable battery in the device, only one green icon of the built-in battery is displayed in the status bar.
- When both batteries is fully charged, the device will select replaceable battery as power source. If the power of the replaceable battery is in low level, the device will switch to built-in battery as power supply.
- When charging the device using the USB port **(9)**, it will switch to external USB power supply, meanwhile charging the built-in battery. And a lightning shaped icon will appear inside the icon of built-in battery.
- It is possible to replace the replaceable battery when the device is power on ( the device will switch its power supply to built-in battery ).

## 7. External Power Supply

Tube series support external power supply, such as mobile Power Bank (5V).

- Connect the external power supply to the USB port **(9)** on Tube.
- The device will switch to external power supply, meanwhile charge the built-in battery pack.
- When the external power supply is turned off, the device will switch to replaceable 18500 battery first without turning off. If there is no replaceable 18500 battery or low power level, the device will switch to the built-in battery pack as power supply.



## 8. Installation

### Mounting On The Weapon

**Warning! It is forbidden to point the riflescope lens at any high intensity energy source, such as laser radiation emitting device or the sun. Any damage that caused by not following instructions are not covered by warranty.**

For accuracy of shooting, please properly mount the Tube series on the weapon.

- The Tube series riflescope is fixed using the mount, such as the Picatinny rail mount included in the package. Tube series is designed with 30mm diameter pipe, also suits 30mm standard mount, such as mounts for the daylight scope. Follow the mounting manufacturer's suggestions on the installation instructions and choose proper tools.
- When mounting the riflescope, adjust the position on the weapon so that proper (comfortable) holding of weapon ensures the distance between the riflescope and eye (eye relief) specified by the **Technical Specifications**. Failure to comply with this recommendation may result in injury to the shooter by the parts of the riflescope eyepiece when shooting.
- It is recommended to install the riflescope as low as possible, also avoid to be in contact with barrel or receiver.
- In order to avoid pinching the riflescope body, a tightening torque for the screws of the mounting rings must be not more than 2.5 Nm. A torque wrench is recommended to control the tightening torque.
- Before using the riflescope before hunting, please refer to **Zeroing** section in this manual to zero your riflescope.
- It is recommended to use an eyeshade **(1)** while using the riflescope in the dark in order to avoid detection of camouflage.

### Power On and Image Settings

- Open the lens cover **(14)**.
- Press the **Power Button (5)** for 2 seconds to power the riflescope on.

- Rotate the diopter adjustment ring **(2)** of the eyepiece to adjust the clarity of icons on the display.
- Rotate the lens focus ring **(13)** to focus on the object being observed.
- Set image mode in the home screen with a short press the **Palette Button (6)**: White Hot, Black Hot, Pseudo Color, Red Hot and Target Highlight.
- Adjust the screen brightness in the home screen with a short press the **Brightness Button (4)** from level 1 to 5.
- Short press the **controller (7)** to set image sharpness (for more details, refer to the **Shortcut Menu** section).
- Select the desired calibration mode in the main menu: Automatic (A), Manual (M) and Background (B). The default mode is A.
- Calibrate the image with a short press of the **Power Button (5)**. Please close the lens cover **(14)** first when in the background calibration mode.
- Open the standby and power off interface with a long press of the **Power Button (5)**. Release the button until a prompt of saving date appears on the screen after counting down from 3 to 0, and the device will switch off after saving data. **Please don't cut off power supply when saving data, otherwise the data may not be saved.**
- Release button before countdown finish, then device will enter the standby mode. Short press the **Power Button (5)** again to wake it up.

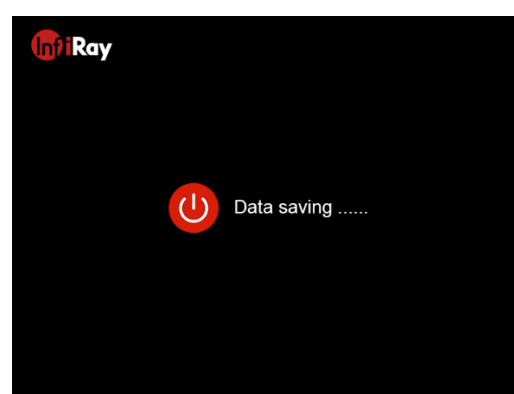
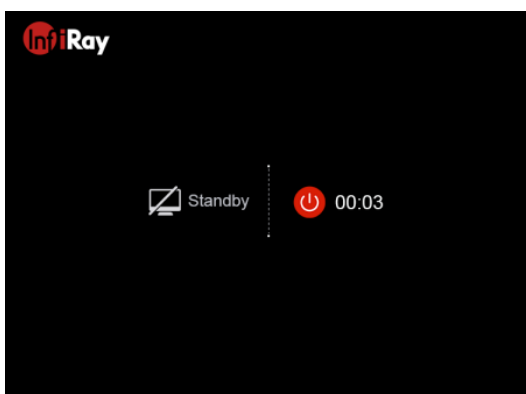

## 9. Zeroing

Tube series feature to use the “**Freeze**” zeroing method. Zeroing is recommended to be done at the temperature close to the riflescope operating temperature.

- Mount the weapon with the riflescope.
- Set a target at a certain distance, such as 100m,200m etc.;
- Adjust riflescope according to the **Powering On and Image Settings** section.
- Select the zeroing profile ( refer to **Zeroing Profile** in Main Menu).
- Press and hold down the controller button **(7)** to enter the Main Menu.
- Rotate the controller ring **(7)** to select **Zeroing** item. Briefly press the controller button **(7)** to confirm the selection and enter the submenu.
- Based on preset target distance, select the zeroing distance in the zeroing submenu. Or add a new distance (refer to **Zeroing – Reset Zeroing Distance** of the Main Menu function).
- After setting the zeroing distance, rotate the controller **(7)** to select **Zeroing** option , and short press the controller button **(7)** to enter zeroing interface (see the Main Menu “**Zeroing - Zeroing Distance - Zeroing Interface**”). The X and Y coordinates of the reticle are displayed in the upper left corner of the screen.
- Aim and shoot the target.
- Observe the location of impact. Suppose that the red cross hairs in the right picture represents the impact point, but the cross is only as a sign and does not appear on the actual interface.
- If the impact point does not match the aiming point (the center of the reticle), keep the reticle center at the aiming point, then press and hold down the **Palette Button (6)** and **Photo Button (3)** at the same time until a



symbol of freeze ❄ appears on the left of the screen, and the image is frozen.

- Move the reticle by rotating the controller ring (7) until the reticle matches the point of impact. Rotate clockwise to move the reticle left or down and counter clockwise to move the reticle right or up.
- When moving the reticle, a white dot appears on the screen, representing the original position of the reticle.
- Briefly press the controller button (7) to switch the movement direction between X and Y. The location of cursor ➤ represents current selected option, and the icon turns into blue.
- When the reticle moves to the impact point, press and hold the controller button (7) to save the new position of the reticle and exit to the home screen.
- Take another shot – the point of impact should now match the aiming point.

## 10. Calibration

Calibration enables to equalize the detector temperature and eliminate the image defects (such as vertical bars, phantom images, etc.).

There are three calibration modes: Automatic(A), Manual(M) and Background(B).

Select the required calibration mode in the Main Menu.

- **A mode(Automatic).** Device will calibrate automatically according to the software algorithm. There is no need to close the lens cover (the internal shutter covers the sensor). Before automatic calibration, there will be a 5 second countdown prompt behind the shutter icon on the status bar, that can be cancelled this calibration during countdown with a short press of the **Power Button (5)**. In this mode, the riflescope may be calibrated by user with the **Power Button (5)**.
- **M mode (Manual).** Press the **Power Button (5)** briefly to activate the shutter calibration without closing the lens cover (the internal shutter covers the sensor).
- **B mode (Background).** Close the lens cover and press **Power Button (5)** briefly. A prompt appears on home screen as “cover lens during calibration”, background calibration starts after 2s.

## 11. Digital Zoom

Tube series riflescope supports to quickly increase the basic magnification from 3.0 to 12.0, enlarging image from 1 time to 4 times.

- In the home screen, rotate the controller ring (7) for a smooth zooming of the base magnification.
- Rotate clockwise to zoom in, counterclockwise to zoom out.
- During zooming, a real-time amplification factor prompt appears on the screen, and disappears in 2s without operation. Meanwhile the top status bar updates with the new magnification.



## 12. Photography and Video Recording

Tube series is equipped with a function for video recording and photography of the observed image which is saved on the built-in 16GB memory storage.

The photo and video files are named with time, so it is suggested to reset the date and time in the Main Menu before using the photo and video functions (refers to **Main Menu - Settings - Date/Time Setting** in this manual) or to synchronize date and time in the InfiRay Outdoor application.

### Photography

- In the home screen, short press the **Photography Button (3)** to take a photo. The image freezes for 0.5 sec with a camera icon  appears on the upper left corner of screen.
- Photos are stored in the built-in storage.

### Video Recording

- In the home screen, long press the **Photography Button (3)** to start video recording.

- When the video recording starts, the icon  and the video recording timer displayed in the HH:MM:SS (hour: minute: second) format will appear on the upper right of the screen.



- When recording, short press **Photography Button (3)** to take a photograph.
- Long press **Photography Button (3)** to stop and save the video recording;
- All videos and photos will be saved in the built-in storage.

#### Tips:

- You can enter and navigate the menu during video recording.
- Recorded photos and videos are saved in built-in memory card of the device in the format IMG\_HHMMSS\_XXX.jpg (for photos), VID\_HHMMSS\_XXX.mp4 (for videos). HHMMSS - Hour/Minute/Second; XXX - three-digit counter (for videos and photos).
- The counter used for the names of multimedia files can't be reset.
- If a file is deleted from the list, its number is not taken by the other file.

#### Caution:

- The maximum duration of a recorded video file is 5 minutes. After this time expires, the video is recorded to a new file automatically.
- The number of the recorded files is limited by the capacity of the internal memory.
- Check the available space of the built-in storage card regularly and move the footage to other storage media to free up the memory card space.
- Graphic data (status bar, icons and menu) in the recorded video and photo files are not displayed.

#### Memory Access

When the device is turned on and connected to a computer, it is recognized by the computer as a flash memory card, which is used to access the device's memory and

make copies of pictures and videos.

- Turn on the riflescope and connect it with the computer via Type-C cable.
- Double click “my computer” on the desktop - double click to open the device named

“Infiray”  - double click and open the device named ‘Internal Storage’



to access built-in memory.

- There are different folders named by time in the storage  20191218 .
- Recorded photos and videos in that day are saved in the folders
- Select desired files or folders to copy or delete.

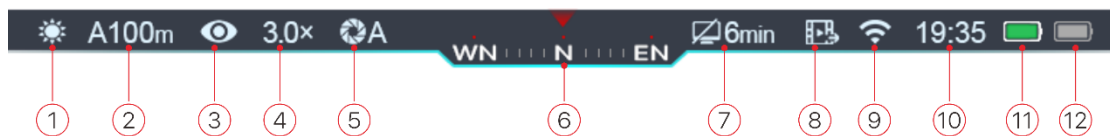

### 13.Status Bar



The status bar is at the top of the screen and shows information on the actual operating status of the riflescope, from left to right are:

1. Image mode (☀️:White Hot; 🌑:Black Hot; 🔥: Red Hot; 🐦: Target Highlighting; 🌈: Pseudo Color)
2. Actual zeroing type and distance (such as A100m)
3. Ultraclear mode (🌀: Ultraclear off; 👁️: Ultraclear on)
4. Current magnification (e.g. 3.0×)
5. Calibration mode (a countdown timer ⌚00:05 will appear instead of the calibration mode with 5 seconds remaining until automatic calibration). The timer will appear only after the microbolometer temperature has stabilized (after 10 minutes of continuous operation of the riflescope). Immediately after turning on the riflescope the shutter calibration activates automatically without displaying the timer.
6. Compass (when it is on)
7. Standby status and time ( e.g. 2 min)

8. Video output (when it is on)
9. Wi-Fi connect (📶: Wi-Fi off; 📶: Wi-Fi on)
10. Clock (in the Main Menu or InfiRay Outdoor application to set time)
11. Replaceable battery power indicator
12. Built-in battery pack discharge level

**Notice:** when icon is green , it means the battery level is more than 20%; the red icon  means in low level and need to charge or replace; when there is a flash icon  inside, means the external power supply and charging the built-in battery pack.

## 14. Shortcut Menu Functions

The basic settings (including reticle type, reticle color, image sharpness, zeroing distance) can be changed in the shortcut menu.

- In the home screen, press the controller button **(7)** to enter the shortcut menu;
- Rotate the controller ring **(7)** to switch between functions, as described below. The selected options will be highlighted in background:
  - **Reticle type:** short press the controller button **(7)** to change the reticle type from 1 to 6.
  - **Reticle color:** short press the controller button **(7)** to change the reticle color among white, black, red and green.
  - **Image sharpness:** short press the controller button **(7)** to change the image sharpness value from 1 to 5.
  - **Zeroing distance:** short press the controller button **(7)** to change default zeroing distance;
- Press and hold the controller button **(7)** to save modifications and exit the menu or wait 5 seconds to exit automatically.



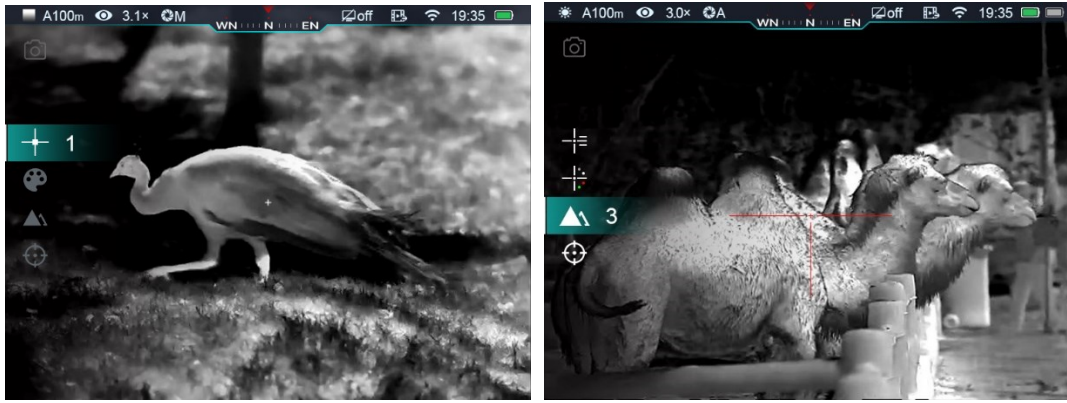

## 15. Main Menu Functions

- Enter the main menu with a long press of the controller button **(7)** in the home screen.
- Rotate the controller ring **(7)** to move among the main menu items.
- Main menu navigation is cyclical: when the cursor **>** reaches the last menu item of the first page, it will continue from the first menu item on the second page. When the cursor **>** is located at the first item of the first page, it will move to the last menu item on the second page will start with a counterclockwise rotation of the controller ring **(7)**.
- Press the controller button **(7)** briefly to adjust the current parameters or open the subitems.
- In all menu interfaces, long press the controller button **(7)** to save modification and exit to the home screen, or short press the **Power Button (5)** to return to the top level menu interface without saving.
- Automatic exit from the main menu to the home screen occurs after 15 seconds of inactivity.
- Upon exit from the main menu the cursor location **>** is stored only for a single working session (i.e. until the riflescope is turned off). Upon restarting the riflescope and entering the menu the cursor will be on the first menu item.









Page 1 of the main menu



Page 2 of the main menu

## Main Menu Contents and Description

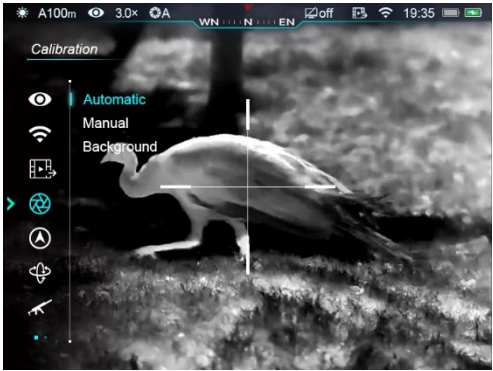
Menu Item	Submenu
<b>Ultraclear Mode</b> 	<b>Turn on/off Ultraclear mode</b> <ul style="list-style-type: none"> <li>● Press and hold the controller button (7) to enter the main menu.</li> <li>● Rotate the controller ring (7) to select the <b>Ultraclear</b> menu item.</li> <li>● Press the controller button (7) briefly to turn on/off the Ultraclear mode, along with the sound of shutter calibration.</li> </ul>
<b>Wi-Fi</b> 	<b>Turn on/off Wi-Fi</b> <ul style="list-style-type: none"> <li>● Press and hold the controller button (7) to enter the main menu.</li> <li>● Rotate the controller ring (7) to select the <b>Wi-Fi</b> menu item.</li> <li>● Briefly press controller button (7) to turn Wi-Fi on/off.</li> </ul>
<b>Video Output</b> 	<b>Turn on/off video output</b> <ul style="list-style-type: none"> <li>● Press and hold the controller button (7) to enter the main menu.</li> <li>● Rotate the controller ring (7) to select the <b>Video Output</b> menu item.</li> <li>● Briefly press controller button (7) to turn video out on/off.</li> <li>● Video out function is enable connectivity with an eternal display or recording device.</li> </ul>
<b>Calibration</b> 	<b>Select calibration mode</b> <p>There are three calibration modes: Automatic(A), Manual (M) and Background (B).</p> <p>The selected calibration mode is displayed in the status bar (see <b>Status</b></p>

	<p><b>Bar</b> section).</p> <ul style="list-style-type: none"> <li>● Press and hold the controller button <b>(7)</b> to enter the main menu.</li> <li>● Rotate the controller ring <b>(7)</b> to select the <b>Calibration Mode</b> menu item.</li> <li>● Press the controller button <b>(7)</b> briefly to enter the <b>Calibration Mode</b> submenu.</li> <li>● Rotate the controller ring <b>(7)</b> to select one of the calibration modes described below: <ul style="list-style-type: none"> <li>- <b>Automatic.</b> The software determines the need for calibration in automatic mode. The calibration process starts automatically.</li> <li>- <b>Manual.</b> The user independently determines the need for calibration based on the quality of the observed image.</li> <li>- <b>Background.</b> Close the lens cover before starting the calibration.</li> </ul> </li> <li>● Press the controller button <b>(7)</b> briefly to confirm your selection.</li> </ul> 
<p><b>Compass</b></p> 	<p><b>Turn on/off the digital Compass function</b></p> <ul style="list-style-type: none"> <li>● Press and hold the controller button <b>(7)</b> to enter the main menu.</li> <li>● Rotate the controller ring <b>(7)</b> to select the <b>Compass</b> menu item.</li> <li>● Briefly press controller button <b>(7)</b> to turn digital compass on/off.</li> <li>● When compass function is turned on, it will reveal in the center of top status bar.</li> </ul>
<p><b>Gravity Sensor</b></p> 	<p><b>Turn on/off the gravity sensor</b></p> <ul style="list-style-type: none"> <li>● Press and hold the controller button <b>(7)</b> to enter the main menu.</li> <li>● Rotate the controller ring <b>(7)</b> to select the <b>Gravity Sensor</b> menu item.</li> </ul>

- Briefly press controller button (7) to turn the gravity sensor on/off.
- Two scales are displayed on the both sides of the screen when the gravity sensor is on.
- The left scale shows tilt angle, and the right one shows pitch angle.



### Select zeroing profile

- Press and hold the controller button (7) to enter the main menu.
- Rotate the controller ring (7) to select the **Zeroing Profile** menu item.
- Press the controller button (7) briefly to enter the **Zeroing Profile** submenu.
- Rotate the controller ring (7) to select one of three profiles (marked with the letters A, B, C).
- Press the controller button (7) briefly to confirm your selection.
- The name of the selected profile appears in the status bar at the top of the display.

### Zeroing Profile



## Zeroing



To zero your riflescope, you need to set a zeroing profile and zeroing distance first. Tube series support the zeroing distance in the range of 1 to 999 m.

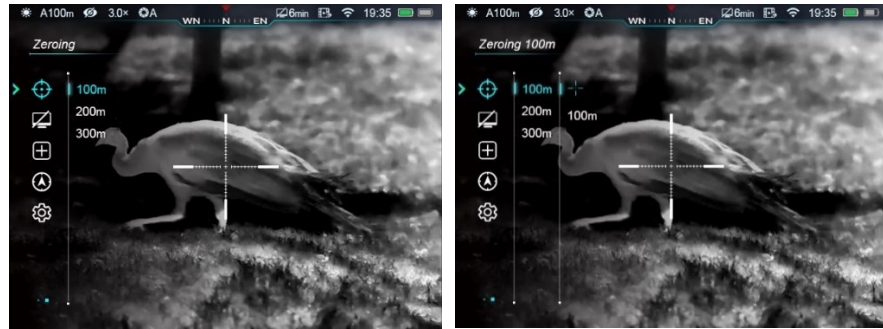

- Press and hold the controller button **(7)** to enter the main menu.
- Rotate the controller ring **(7)** to select the **Zeroing** menu item.
- Press the controller button **(7)** briefly to enter the **Zeroing** submenu (zeroing distance selection).
- Rotate the controller ring **(7)** to select one **Zeroing Distance** based on the preset target distance.
- Press the controller button **(7)** briefly to enter the **Zeroing Distance** submenu as below.





## Zeroing



If the zeroing distance is the same as the preset distance, you can zero your riflescope directly as follows.

- Rotate the controller ring **(7)** to select **Zeroing**  menu item in the **Zeroing Distance** submenu.
- Press the controller button **(7)** briefly to enter the **Zeroing** interface.
- The X and Y coordinates of the reticle are displayed in the upper left corner of the screen.
- Aim and shoot the target.
- Press and hold down the **Palette Button (6)** and **Photo Button (3)** at the same time until a symbol of freeze  appears on the left of the screen,

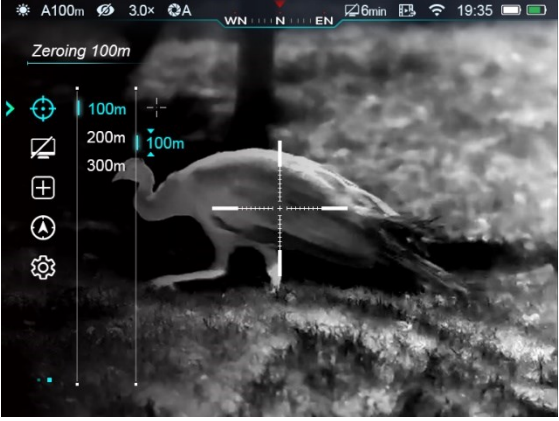
		<p>and the image is frozen.</p> <ul style="list-style-type: none"> <li>● Adjust the reticle position by rotating the controller ring (7) until the reticle matches the point of impact. For a detailed description of the reticle adjusting, refer to the <b>Zeroing</b> section.</li> </ul> 
	<p><b>Reset Zeroing Distance</b></p> <p>▼ 000 ▲</p>	<p>If the zeroing distance is not same as the preset object, you can set the distance here.</p> <ul style="list-style-type: none"> <li>● Select a <b>non-primary distance</b> and enter the submenu for operation with a brief press of the controller button (7).</li> <li>● Rotate the controller ring (7) to select <b>Reset Zeroing Distance</b> menu item.</li> <li>● Press the controller button (7) briefly, two triangle icons will appear above and below the number 0.</li> <li>● Rotate the controller ring (7) to reset the value of the number from 0 to 9.</li> <li>● Press the controller button (7) briefly to switch among the three numbers.</li> <li>● After resetting, press and hold the controller button (7) to save and exit.</li> <li>● The new zeroing distance appears in the status</li> </ul>

		<p>bar at the top of the display.</p> 
<p><b>Standby Settings</b></p> 		<p><b>Set standby status and time</b></p> <ul style="list-style-type: none"> <li>● Press and hold the controller button (7) to enter the main menu.</li> <li>● Rotate the controller ring (7) to select the <b>Standby Settings</b> menu item.</li> <li>● Press the controller button (7) briefly to enter the <b>Standby Settings</b> submenu.</li> <li>● Rotate the controller ring (7) to select one of four options (2min, 4min, 6min, off).</li> <li>● Press the controller button (7) briefly to confirm selection and reveal in the status bar at the top of the display.</li> <li>● If the off is selected, it means the standby mode is turned off.</li> </ul> <p><b>Caution:</b></p> <ul style="list-style-type: none"> <li>- The standby mode will be active when the riflescope is tilted up or down at an angle of more than 70° and left or right at an angle of more than 30°.</li> <li>- The riflescope will not stand by while it is in the firing state.</li> </ul>



**Pixels  
Defect  
Correction**



Defect pixels are pixels that do not change brightness compare with others on the image, they are either brighter or darker than surrounding pixels. Tube series offer the possibility of removing any defective pixels on the sensor using software, as well as to cancel any deletion.





- Press and hold the controller button **(7)** to enter the main menu.
- Rotate the controller ring **(7)** to select the **Pixels Defect Correction** menu item.
- Press the controller button **(7)** briefly to enter the **Pixels Defect Correction** interface.
- A small cross cursor instead of the reticle will appear on the center of the screen.
- The Picture in Picture (PIP) window will appear on the lower left corner of the screen.
- The cursor coordinates and the number of the corrected pixels are displayed on the right of the PIP window.
- On the right of PIP window, there are some prompts showing the movement direction of the cursor in X-axis (horizontal), Y-axis (vertical) and number of corrected pixels.
- Press the controller button **(7)** briefly to switch the direction between X-axis and Y-axis.
- Rotate the controller ring **(7)** to move the cursor to align with the defective pixel.
- Delete the defective pixel with a short press of the **Power Button (5)** .

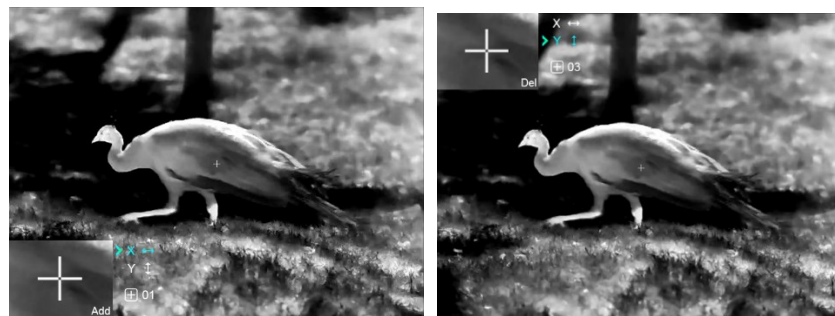

When the pixel has been successful deleted, the **Add** message will appear on the PIP window for a short time.

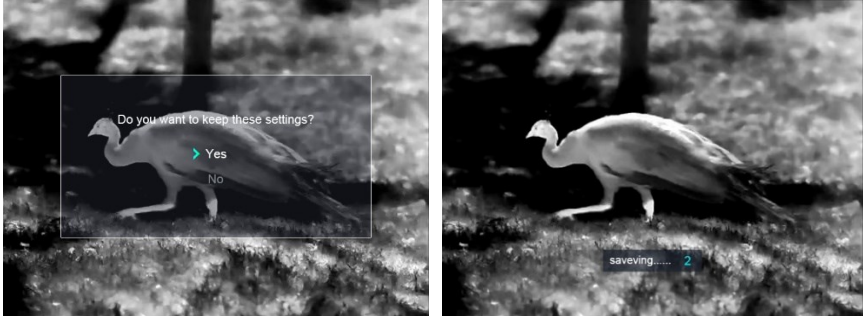
- Then, delete the next defective pixel by moving the cursor across the display.
- Press the **Power Button (5)** briefly in the same position as the calibrated defective pixel to cancel the pixel correction, and the Del message will appear on the PIP window for a short time. But it is only limited to not exiting this correction.
- The amount of defect pixels changes each time adding or deleting pixels correction.
- The PIP and the prompt information will move to the upper left of the screen when cursor moves near the lower left corner.
- Press and hold the **Power Button (5)** until display shows “Do you want to save these settings?” and “Yes” and “No” options.
- Rotate the controller ring **(7)** to select ‘Yes’ to save and exit, or select ‘No’ to cancel saving and exit.
- Press the **Power Button (5)** briefly to confirm your selection.
- When Yes is selected, a **5-second Saving** countdown appears on the screen. It will exit to the home screen after the prompt **Saving successful** appears.



	
<p><b>Compass Calibration</b></p> 	<p><b>Calibrate the digital compass</b></p> <ul style="list-style-type: none"> <li>● Press and hold the controller button <b>(7)</b> to enter the main menu.</li> <li>● Rotate the controller ring <b>(7)</b> to select the <b>Compass Calibration</b> menu item.</li> <li>● Press the controller button <b>(7)</b> briefly to enter the <b>Compass Calibration</b> interface.</li> <li>● An icon like a triaxial coordinate system appears on the screen.</li> <li>● Follow the icon prompt to rotate the riflescope along three axes at least 360 degrees each axis in the 15 seconds.</li> <li>● After 15s, the calibration is finished and exit to the home screen.</li> </ul> 
<p><b>Settings</b></p> 	<p><b>Select general settings</b></p> <ul style="list-style-type: none"> <li>● Press and hold the controller button <b>(7)</b> to enter the main menu.</li> <li>● Rotate the controller ring <b>(7)</b> to select the <b>Settings</b> menu item.</li> <li>● Press the controller button <b>(7)</b> briefly to enter the submenu.</li> <li>● This menu item allows you to configure the following settings.</li> </ul>



Date



### Date setting

- Press the controller button **(7)** briefly to enter the **Date** submenu. The date is displayed in yy/mm/dd format.
- Rotate the controller ring **(7)** to select the desired year, month and day.
- Press the controller button **(7)** briefly to switch between digits.
- Press and hold down the controller button **(7)** to save your selected date and exit from the submenu.









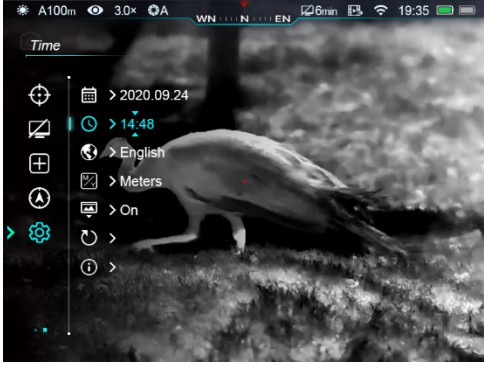

Time

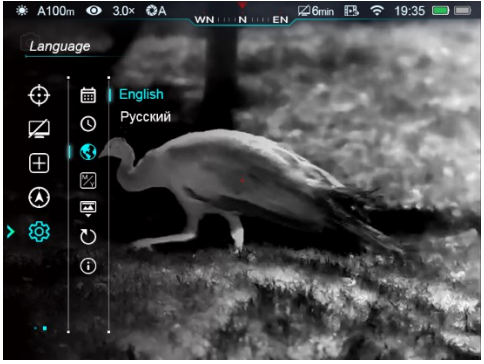



### Time setting

- Press the controller button **(7)** briefly to enter the **Time** submenu. The time is displayed in 24-hours format.
- Rotate the controller ring **(7)** to select the hour and

		<p>minute value.</p> <ul style="list-style-type: none"> <li>● Press the controller button <b>(7)</b> briefly to switch between hour and minute.</li> <li>● Press and hold down the controller button <b>(7)</b> to save your selected date and exit from the submenu.</li> </ul> 
<p>Language</p> 		<p><b>Language selection</b></p> <ul style="list-style-type: none"> <li>● Press the controller button <b>(7)</b> briefly to enter the <b>Language</b> submenu.</li> <li>● Rotate the controller ring <b>(7)</b> to select the language between English and Russian.</li> <li>● Confirm your selection with a short press of the controller button <b>(7)</b>.</li> <li>● Return to submenu will happen automatically.</li> </ul> 
<p><b>Units of Measure</b></p> 		<p><b>Units of measurement selection</b></p> <ul style="list-style-type: none"> <li>● Press the controller button <b>(7)</b> to enter the <b>Units of measure</b> submenu.</li> </ul>

		<ul style="list-style-type: none"> <li>● Rotate the controller ring (7) to select the unit of measurement -meters or yards.</li> <li>● Confirm your selection with a short press of the controller button (7).</li> <li>● Return to submenu will happen automatically.</li> </ul> 
	<p><b>Status Auto Hiding</b></p> 	<p><b>Turn status auto hiding on/off</b></p> <ul style="list-style-type: none"> <li>● Rotate the controller ring (7) to select <b>Status Auto Hiding</b> menu item.</li> <li>● Press the controller button (7) briefly to enter the <b>Status Auto Hiding</b> submenu.</li> <li>● Rotate the controller ring (7) to select <b>on</b> or <b>off</b>.</li> <li>● Confirm your selection with a short press of the controller button (7).</li> <li>● Return to the submenu will happen automatically.</li> </ul> 
	<p><b>Factory Reset</b></p> 	<p><b>Reset to factory settings</b></p> <ul style="list-style-type: none"> <li>● Rotate the controller ring (7) to select <b>Factory Rese</b> menu item.</li> </ul>

		<ul style="list-style-type: none"><li>● Press the controller button <b>(7)</b> briefly to enter the <b>Factory Rese</b> submenu.</li><li>● Rotate the controller ring <b>(7)</b> to select “Yes” to reset to the factory settings or “No” to cancel the action.</li><li>● Confirm your selection with a short press of the controller button <b>(7)</b>.</li><li>● The riflescope will reboot If ‘Yes’ is selected;</li><li>● If ‘No’ is selected, the action will be cancelled and will return to the submenu.</li></ul> <p>The following settings will be returned to the defaults:</p> <p><b>Image mode:</b> White Hot;</p> <p><b>Zeroing:</b> A100</p> <p><b>Ultraclear mode:</b> Off;</p> <p><b>Magnification:</b> 3.0 x;</p> <p><b>Calibration mode:</b> Automatic;</p> <p><b>Digital Compass:</b> Off</p> <p><b>Standby:</b> Off;</p> <p><b>Video output:</b> Off</p> <p><b>Wi-Fi:</b> Off</p> <p><b>Gravity Sensor:</b> Off</p> <p><b>Language:</b> English</p> <p><b>Units of Measure:</b> Meter</p> <p><b>Status Auto Hiding:</b> Off</p>
--	--	---

		
	<p><b>Info</b></p> 	<p><b>Show device information</b></p> <ul style="list-style-type: none"> <li>● Rotate the controller ring (7) to select <b>Info</b> menu item.</li> <li>● The relevant information of rifle will be shown by a short press of the controller button (7).</li> <li>● This item allows the user to view the following information about the riflescope: the product model, GUI version, SYS Info, Boot version, FPGA, PN and SN number of the riflescope, Hardware version.</li> <li>● Press and hold the controller button (7) to return to the submenu.</li> </ul> 

## 16. PIP Function

The PIP (Picture in Picture) function allows you to see both a magnified image in a particular window and the main image.

- Press and hold the **Palette Button (6)** in the home screen to turn on/off the PIP function.

- A separate 'window' is appeared on the top of the display simultaneously with the main image.
- The image in the separate window is the image of the reticle area enlarged by two times.
- Rotate the controller ring (7) to enlarge the main image, the PIP image will be enlarged 2 times synchronously.



## 17. Stadiametric Rangefinder

Tube series is equipped with a stadiametric rangefinder, which allows you to estimate the approximate distance to an object, if its size is known.

- In the home screen, press and hold the **Brightness Button (4)** to switch the stadiametric rangefinder function on/off.
- The display will show two horizontal lines for measurement, the icons and numbers of the measured distance for three objects on the right.

- There are three predefined values for objects:
  - **Deer:** 1.7m high
  - **Boar:** 0.9m high
  - **Hare:** 0.2m high

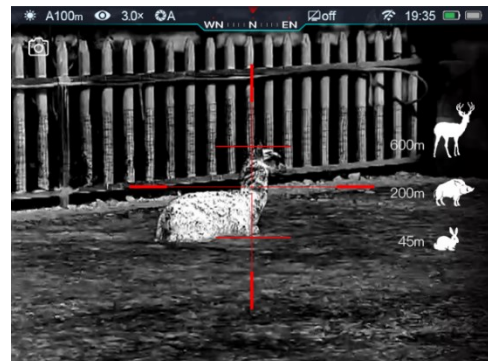

- Locate the object in the middle of the measurement lines, and rotate the controller ring (7) to move the lines so that the object is located directly between the measurement lines. Rotate clockwise to extend the lines and counterclockwise to shrink. A target range is automatically recalculated along with movement.
- The center and color of the measurement lines is the same as the reticle.
- To change the unit of measurement (meters or yards), please refer to the **Main Menu - Settings - Unit of measurement** submenu.
- Long press **Brightness Button (4)** to exit the stadiametric rangefinder mode.





## 18. Status Auto Hiding

This function enables automatic hiding of the GUI information in the interface other than the reticle, so to make the image unobtrusive.

- Rotate the controller ring (7) to select **Settings** menu item in the Main Menu.
- Press the controller button (7) briefly to enter the **Settings** submenu.
- Rotate the controller ring (7) to select **Status Auto Hiding** menu item.
- Press the controller button (7) briefly to enter the **Status Auto Hiding** submenu.
- Rotate the controller ring (7) to select **On** or **Off**.
- Confirm your selection with a short press of the controller button (7).
- When the selecting is **On**, the GUI icons in the interface including the status bar will be automatic hidden after 8 seconds without any operation. Only the image and the reticle will be displayed.
- The GUI information will be displayed again with the press of any button.
- Only after the GUI is displayed, the button and menu can be manipulated.

## 19. Wi-Fi Function

Tube series has a function for wireless communication with mobile device (smartphone or tablet) via Wi-Fi.

- To enable the wireless module, enter the main menu by long pressing the controller button (7).
- Rotate the controller ring (7) to select the **Wi-Fi** menu item.
- Press the controller button (7) briefly to turn on/off Wi-Fi module.
- When the Wi-Fi module is off, the icon displayed in the status bar is , and the icon is  when Wi-Fi is on.
- The riflescope is recognized by an external device under the name "Tube\_XXXXXX", XXXXXX is the last six digits of the serial number that consist of numbers and letters.
- Select this Wi-Fi signal, and enter the password (default is 12345678) on the mobile to set up the connection.
- When Wi-Fi is successfully connected, users can manipulate the device via App.

- Launch **InfiRay Outdoor** application on your mobile device (see **Update and APP** section).

## Set Wi-Fi name and password

The Wi-Fi name and password of Tube series can be reset in the **InfiRay Outdoor** application.

- After connected with the mobile device, find and click the "setting" icon  in the **InfiRay Outdoor** to enter the setting interface .
- In the text box, enter and submit the new name (SSID) and password of the Wi-Fi.
- It needs to reboot the device to take the new name and password effect.

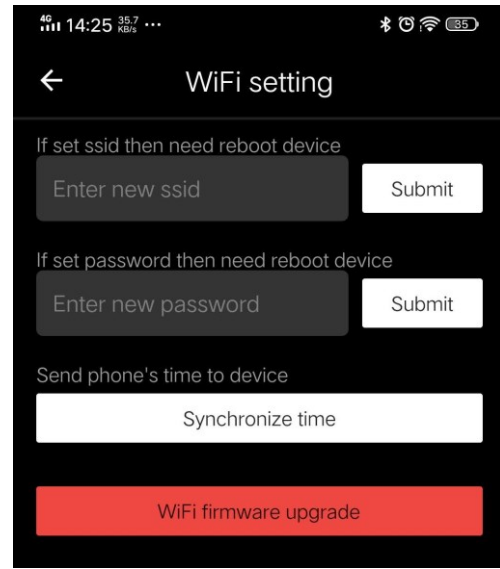

**Note!** When factory Settings are restored, the Wi-Fi name and password are also restored to factory default settings.

## 20. Updates and InfiRay Outdoor

Tube series thermal imaging riflescopes support **InfiRay Outdoor** technology, which allows you to transmit the image from the thermal imager to the smartphone or tablet via Wi-Fi in real time mode.

You can find detailed instructions on **InfiRay Outdoor** in the separate brochure at the site [www.xinfrared.com](http://www.xinfrared.com).

The design of the riflescope provides the software update option. Updating is possible via the **InfiRay Outdoor** application. Also, it is feasible to download and update software from the official website: [www.xinfrared.com](http://www.xinfrared.com).

### About InfiRay Outdoor

- You can get **InfiRay Outdoor** application in the official website: [www.xinfrared.com](http://www.xinfrared.com); or search “InfiRay Outdoor” in App store to download App; or scan the following QR code to download.



- When installation completed, open InfiRay Outdoor application.
- If your riflescope is already connected with mobile device, please switch on the mobile data in mobile device. After connection, the update detection is performed automatically with a prompt in the application. Click ‘Now’ to download the updates or click ‘Later’ to update later.
- **InfiRay Outdoor** will automatically store the last connected device. So, if the riflescope has not connected with your mobile device, but linked to **InfiRay Outdoor** before, the update prompt will appear if there is an update when turning on **InfiRay Outdoor**. You can download the update first via mobile Wi-Fi and then connect the riflescope with mobile device to finish the update.
- After finishing the update, the device will root.

## 21. Technical Inspection

It is recommended to carry out a technical inspection each time before using the riflescope.

Check the following:

- The riflescope appearance (there should be no cracks on the body).
- The condition of the object lens and eyepiece (there should be no cracks, greasy spots, dirt or other deposits).
- The state of rechargeable battery (it should be charged).

- The controls/buttons should be in working order.

## 22. Maintenance

The maintenance should be carried out at least twice a year and includes the following steps:

- Wipe the external surface of metal and plastic parts off dust with a cotton cloth. Silicone grease may be used for cleaning process.
- Clean the electric contacts and battery slots on the riflescope using a non-greasy organic solvent.
- Check the optics of the lens and the eyepiece. If necessary, remove the dirt and sand from the optics (it is perfect to use a non-contact method). Cleaning of the exterior of the optics should be done with cleaners designed especially for this purpose.

## 23. Troubleshooting

The table lists all the problems that may occur when operating the riflescope. Carry out the recommended checks and troubleshooting steps in the order shown in the table. If there are defects that are not listed in the table or it is impossible to repair the defect yourself, return the riflescope for repair service.

<b>Fault</b>	<b>Probable Cause</b>	<b>Solution</b>
Riflescope will not turn on.	Batteries are completely discharged.	Charge the battery.
Riflescope will not work with an external power supply.	USB cable is damaged.	Replace USB cable.
	External power source is discharged.	Check the external power source.
The image is fuzzy, not clear, not balanced, with strings	Calibration is required.	Perform image calibration according to the <b>Calibration</b> section of this manual.

The Image is too dark.	Brightness level is too low.	Adjust brightness of screen.
The GUI is clear, but the image is fuzzy.	The lens is not focused.	Adjust the image sharpness by rotating the lens adjuster.
	There is dust or condensate on the interior or exterior optical surfaces of the lens.	Wipe off the outside optical surfaces with a soft cotton cloth. Let the riflescope dry by leaving it in a warm environment for 4 hours.
The aiming reticle shifts after firing rounds.	The riflescope is not mounted securely or the mount is not fixed on the riflescope.	Check that the riflescope has been securely mounted. Make sure you are using the same type and caliber of the bullets as when the riflescope and weapon were initially zeroed. If your riflescope was zeroed in the summer and using in the winter (or the other way round), a slight shift of the zero point is possible.
The riflescope will not focus.	Wrong settings.	Adjust the riflescope according to the <b>Powering On and Image Setting</b> section. Check the outer surfaces of the objective lenses and eyepiece and, where necessary, wipe them from dust, condensation, frost, etc. In cold weather, you can use special anti-fogging coatings (e.g., the same as for corrective glasses).
The riflescope can't	Wrong Wi-Fi password.	Input correct password

connect with smartphone and tablet.	Too many Wi-Fi signals around the riflescope.	Move the device to an area with no or fewer Wi-Fi signals.
Wi-Fi signal is missing or interrupted	Smartphone or tablet is out of range of a strong Wi-Fi signal. There are obstacles between the device and the smartphone or tablet (e.g., concrete walls).	Relocate the device until Wi-Fi signal is stable.
The image of the object being observed is missing.	Observation through glass.	Remove the glass from the field of vision.
Image quality is too low or the detection range is reduced.	These problems may occur during the observation in adverse weather conditions (snow, rain, fog etc.).	
When the riflescope is used in low temperature conditions, the image quality of the surroundings is worse than in positive temperature conditions.	<p>In positive temperature conditions, objects being observed (surroundings and background) heat up differently because of thermal conductivity, thereby generating a high temperature contrast. Accordingly, image quality produced by the thermal imager will be higher.</p> <p>In low temperature conditions, object objects being observed (background) will cool down to roughly the same temperature, as a rule, and thus the temperature contrast is substantially reduced and image quality (zoom) goes down. This is a distinctive feature of the thermal imager.</p>	